

# Holzmedia Smart Furniture

*for the perfect synthesis of fine furniture and media technology*

## Overall program

# Price list 2025

including all data, dimensions  
and detailed information

valid from 01.04.2025

## Holzmedia Elements

Media furniture for the individual integration of displays and media technology

Page



### UC-Display column\_W6

Size M	10 - 11
Add-on tables - Size M	12 - 13
Size L	14 - 15



### Media column\_W8

Size M	16
Size L	17
Size XL	18 - 19
Size XXL	20 - 21
Size M <sup>2</sup>	22 - 23
Size L <sup>2</sup>	24 - 25
Size XL <sup>2</sup>	26 - 27



### Media furniture\_S1

Size M	29
Size L	30
Size XL	31





### LED-Media wall\_W9

Size 110 <b>new</b>	32 - 35
Size 146 <b>new</b>	36 - 39
Size 165 <b>new</b>	40 - 43
Size 110 <sup>2</sup> <b>new</b>	44 - 45

General Elements options	46
Replacement bezel plates for Media column_W8	47

## Holzmedia Additions

Supplementary furniture that complements our performance profile

	Page
	<b>Lectern_X3</b> 49
	<b>Media Cube_X4</b> 50 - 51
	<b>Display Caddy_X5</b> <span style="background-color: #e91e63; color: white; padding: 2px;">new</span> 52

## Holzmedia Tables

Table systems for conference and meetings rooms



### Conference table\_C12

in rectangular / rounded boat shape	54
in trapezium shape	55
in triangular shape	56
in V-shape	57 - 58
options	59
<b>General note / instruction</b>	<b>62</b>
<b>General terms of business</b>	<b>63</b>
<b>Contact</b>	<b>64</b>



Holzmedia  
Elements

# Media furniture

for the individual integration of  
display and media technology

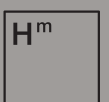

Holzmedia

**new** LED Media wall\_W9  
Now also mobile



## Holzmedia Elements

The perfect product for every requirement

### UC-Display colum\_W6

all-purpose, standardized modular system □ especially for the integration of VC soundbars □ for height-adjustable positioning of 50"- 80" displays □ wall mounted or freestanding □ a price-oriented solution for small to medium-sized rooms □ in 2 sizes □ sustainably flexible



### Media furniture\_S1

specialized piece of furniture for the interactive working with touch displays □ height-adjustable by electric motor □ generous storage space for additional technology □ for display sizes from 55"-98" □ for sophisticated rooms / auditoriums / projects □ can be customized on request, also in color



## Media column\_W8

versatile media column □ perfectly prepared for the integration of professional video conferencing technology □ with generous storage space □ for display sizes from 55"- 110" □ wall mounted or mobile □ for sophisticated rooms / projects □ can be customized on request, also in color



## LED-Media wall\_W9

concept furniture for large-format LED panels □ perfectly prepared for the integration of professional video conferencing technology as well as powerful speaker systems □ standard version for panel sizes from 108" - 165" □ also mobile □ customizable on request for nearly any size and format



# Holzmedia Elements overview

The perfect product for every requirement

	Display sizes				LED panel sizes (diagonal)			Dual display is possible
	max. display weight							
	M	L	XL	XXL	-110	-146	-165	
	55" - 65"	70" - 80"	84" - 98"	100" - 110"	108" - 110"	135" - 146"	162" - 165"	
UC Display column <b>W6</b>	■ 40 kg	■ 60 kg						■ wall mounted with dual display board
Media column <b>W8</b>	■ 60 kg	■ 80 kg	■ 100 kg	■ 120 kg				■ except of XXL
Media furniture <b>S1</b>	■ 60 kg	■ 100 kg	■ 130 kg					□ wall mounted
LED-Media wall <b>W9</b>					■	■	■	■ 2 x 110" larger on request

■ = standard

□ = individual / on request

✗ = not possible



Holzmedia Elements



Wall mounted	Mobile with base plate	Freestanding with base plate	VC integration is possible	Speaker integration is possible	Variable display height/ bottom edge	Standard colors W (arctic white) B (lava black)	Individual colors
■	×	■ L- or T-metal foot	■ by means of bezel plates	×	■ 70 -120 cm in increments of 10 cm	W / B	×
■	■ also dual	□	■ optional	■		W / B	■
■	■	×		■ optional	■ infinitely variable with electric motor	W / B	■
■	■	□	■ optional	■ optional		W / B	■

# UC-Display column\_W6 M (usually available from stock on short notice!)

for 50" to 65" displays  
with up to 40 kg weight

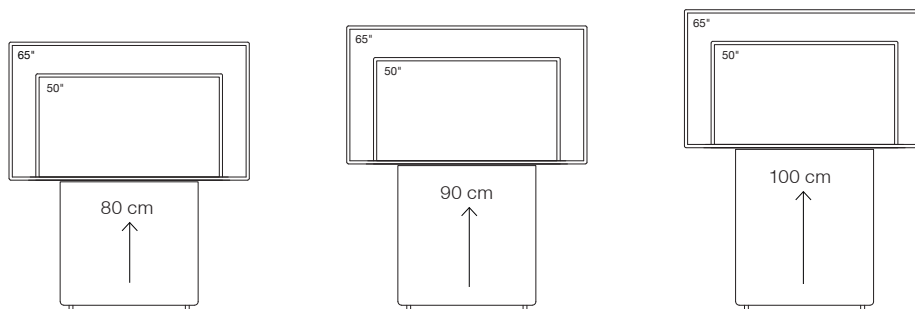

**Type / Design**

Housing and front cover made of MDF, finished with structure lacquer.  
For variable height display mounting/-positioning. Display mount not included.

Base furniture with plate height	80 cm	90 cm	100 cm
<b>Dimensions (W x D x H)</b>			
Furniture, outside	850 x 150 x 1430 - 1830 mm	850 x 150 x 1430 - 1830 mm	850 x 150 x 1430 - 1830 mm
Technology housing	650 x 115 x 760 mm	650 x 115 x 860 mm	650 x 115 x 960 mm
<b>Requirements for display integration</b>			
- max. display width	1600 mm	1600 mm	1600 mm
- max. display weight	40 kg	40 kg	40 kg
- recomm. display depth (incl. mount)	95 - 115 mm	95 - 115 mm	95 - 115 mm
- space for display mount (W x H)	645 x 580 mm	645 x 580 mm	645 x 580 mm
<b>Color / Item number</b>			
<b>arctic white</b>	<b>10072</b>	<b>10073</b>	<b>10074</b>
<b>basis rate for 1 piece</b>	<b>1.790 Euro</b>	<b>1.845 Euro</b>	<b>1.895 Euro</b>
<b>lava black</b>	<b>10579</b>	<b>10580</b>	<b>10581</b>
<b>basis rate for 1 piece</b>	<b>1.790 Euro</b>	<b>1.845 Euro</b>	<b>1.895 Euro</b>
excluding transportation (order of 3 more = scaled conditions!)	on request	on request	on request
<b>Shipping within Europe</b>	Delivery of 1-4 pieces per pallet (further units = same price)	12029	<b>390 Euro</b>
<b>Delivery and instalation</b>		on request	

Options	Surface / Color	Item number	Sales price
<b>Dual display board M<sup>2</sup></b> - for 2 x 50" to 65" displays, dimensions 2200 x 610 mm (W x D) Can only be used with wall attachment!	black MDF, clearly structure lacquered	10767	1.090 Euro
<b>VC camera mount</b> - for position over display, space 240 x 165 mm (W x D) - for position below display, in front of corresponding bezel plate M (10909 / 10910), space 300 x 240 mm (W x D)	metal, powder coated, black	10033	220 Euro
	metal, powder coated, black	10919	220 Euro
<b>L-foot</b> for free positioning on a wall, dimensions 740 x 305 mm (W x D)	metal, powder coated, black	10076	590 Euro
<b>T-foot</b> for free positioning in a room, dimensions 740 x 410 mm (W x D)	metal, powder coated, black	10077	690 Euro

## + complementary bezel plates - size M

for the integration of UC-systems / VC-cameras as well as control panels and connector panels

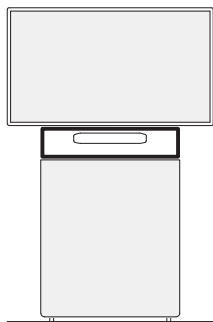

### Type / Design

Made of MDF, finished with structure lacquer. In width of 85 cm.

### Universal

without cutout\*

### Height 10 cm

arctic white lava black



Item number

10079 10582

Base price for 1 unit\*\*\*

170 Euro 170 Euro

### Height 20 cm

arctic white lava black

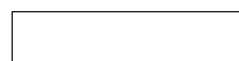

10082 10585

220 Euro 220 Euro

### Height 30 cm\*\*

arctic white lava black



10086 10589

275 Euro 275 Euro

### Special - height 20 cm:

... for POLY X30 + R30

Set, incl. mounting device

Item number

11955 11957

Base price for 1 unit\*\*\*

330 Euro 330 Euro

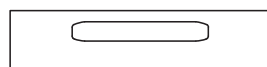

... for POLY STUDIO

Set, incl. mounting device

Item number

10729 10734

Base price for 1 unit\*\*\*

330 Euro 330 Euro

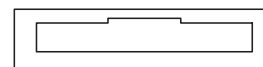

... for Sennheiser TC Bar S new

Set, incl. mounting device

Item number

12519 12520

Base price for 1 unit\*\*\*

330 Euro 330 Euro

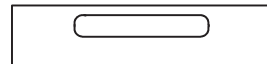

... for Yealink Smart Vision 40 new

Set, incl. mounting device

Item number

12308 12309

Base price for 1 unit\*\*\*

330 Euro 330 Euro

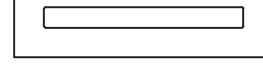

... for Jabra PanaCast 50

Set, incl. mounting device

Item number

11215 11216

Base price for 1 unit\*\*\*

330 Euro 330 Euro

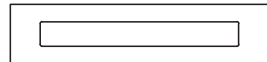

Universal bezel

with tray und cable outlet,  
for example for Lenovo Think Smart

Item number

11211 11212

Base price for 1 unit\*\*\*

330 Euro 330 Euro



Universal UC body

for VC bars up to 570 x 115 x 120 mm

Item number

11397 11398

Base price for 1 unit\*\*\*

330 Euro 330 Euro

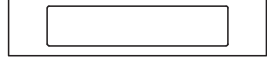

... for mount VC camera

(exclusive mount 10919)

Item number

10909 10910

Base price for 1 unit\*\*\*

270 Euro 270 Euro



Universal mounting device

without bezel, with depth compensation  
for systems wider than 85 cm

Item number

MDF, black

10964

Base price for 1 unit\*\*\*

90 Euro

Shipping within Europe

10092

30 Euro

\* Custom cutouts / drilled holes [from 10 pieces](#) on request possible.

\*\* Can be used in combination with 80 cm and 90 cm high front panel (the height of the lower edge of the display in this case is max. 120 cm).

\*\*\* plus transport/delivery | order of 3 or more = scaled conditions

# Add-on table\_W6 - size M (usually available from stock on short notice!) in height 74 cm - sitting height

for 50" to 65"- displays with up to 40 kg weight

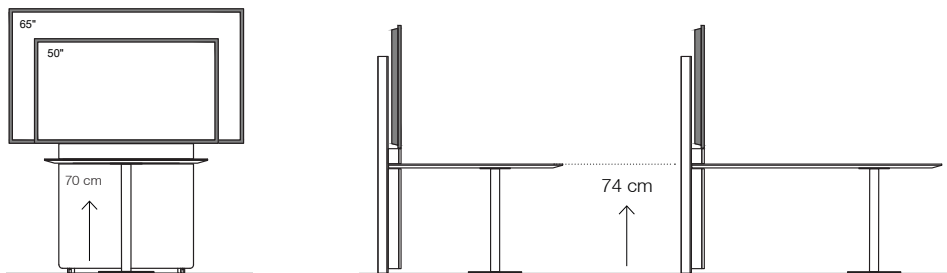

in / to combination  
+ Base furniture with plate height 70 cm

**Type / Design**

Housing and front cover made of MDF, finished with structure lacquer.  
For variable height display mounting/-positioning. Display mount not included.

**Dimensions (W x D x H)**

Furniture, outside 850 x 150 x 1430 - 1830  
Technology housing 650 x 115 x 660 mm

**Requirements for display integration**

- max. display width 1600 mm  
- max. display weight 40 kg  
- recomm. display depth (incl. mount) 95 - 115 mm  
- space for display mount (W x H) 645 x 580 mm

**Color / Item number**

<b>arctic white</b>	<b>11227</b>	<b>lava black</b>	<b>11228</b>
<b>basis rate for 1 piece</b>	<b>1.740 Euro</b>	<b>basis rate for 1 piece</b>	<b>1.740 Euro</b>

excluding transportation  
(order of 3 more = scaled conditions!)

W6 Add-on table 110 for up to 3 people, sitting height	Type / Design Dimension in mm	Color / Surface	Item number	Sales price
	Trapezium shape with rounded edges 1180 x 800 / 1030 x 25 (W x D x H)	<b>Melamin white, chipboard*</b> straight edge, for data connection panel with frame	T: 11253	<b>1.580 Euro</b>
	Table leg with base plate, black	<b>Fenix white, table top in MDF</b> chamfered edge, data connection panel frameless possible	T: 11259	<b>2.320 Euro</b>
		<b>Fenix black, table top in MDF</b> chamfered edge, data connection panel frameless possible	T: 11263	<b>2.320 Euro</b>

W6 Add-on table 160 for up to 5 people, sitting height	Type / Design Dimension in mm	Color / Surface	Item number	Sales price
	Trapezium shape with rounded edges 1680 x 800 / 1030 x 25 (W x D x H)	<b>Melamin white, chipboard*</b> straight edge, for data connection panel with frame	T: 11257	<b>1.895 Euro</b>
	Table leg with base plate, black	<b>Fenix white, table top in MDF</b> chamfered edge, data connection panel frameless possible	T: 11260	<b>2.850 Euro</b>
		<b>Fenix black, table top in MDF</b> chamfered edge, data connection panel frameless possible	T: 11264	<b>2.850 Euro</b>

**Shipping within Europe** Delivery of 1-3 pieces per pallet (further units = same price) 11278 **390 Euro**

**Delivery and instalation** on request

Options	Surface / Color	Item number	Sales price
<b>L-Foot</b> for free positioning on a wall, dimensions 740 x 305 mm (W x D)	metal, powder coated, black	10076	590 Euro
<b>T-Foot</b> for free positioning in a room, dimensions 740 x 410 mm (W x D)	metal, powder coated, black	10077	690 Euro

Prices = net sales prices, excluding VAT (in Euro)

\*Delivery time for melamin table tops, as well as tabletops with cutouts, is about 8 weeks.

## Add-on table\_W6 - size M (usually available from stock on short notice!) in height 105 cm - standing height

for 50" to 65"- displays with up to 40 kg weight

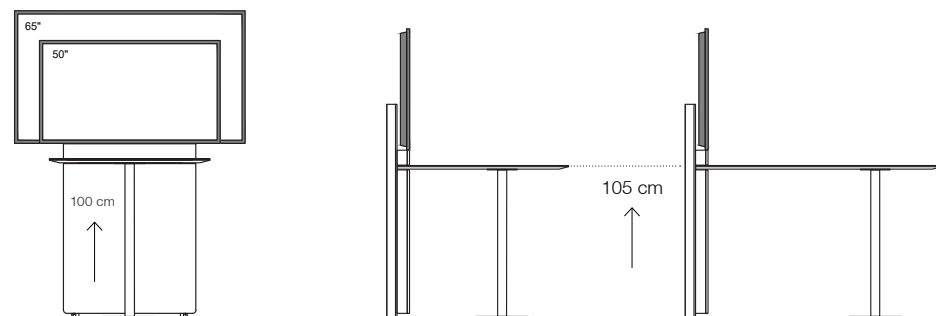

in / to combination  
+ Base furniture with plate height 100 cm

### Type / Design

Housing and front cover made of MDF, finished with structure lacquer.  
For variable height display mounting/-positioning. Display mount not included.

### Dimensions (W x D x H)

Furniture, outside 850 x 150 x 1430 - 1930  
Technology housing 650 x 115 x 960 mm

### Requirements for display integration

- max. display width 1600 mm  
- max. display weight 40 kg  
- recomm. display depth (incl. mount) 95 - 115 mm  
- space for display mount (W x H) 645 x 580 mm

### Color / Item number

arctic white basis rate for 1 piece	10074 1.895 Euro	lava black basis rate for 1 piece	10581 1.895 Euro
--	---------------------	--------------------------------------	---------------------

excluding transportation  
(order of 3 more = scaled conditions!)

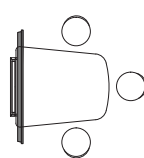
W6 Add-on table 110 for up to 3 people, sitting	Type / Design Dimension in mm	Color / Surface	Item number	Sales price
	Trapezium shape with rounded edges 1180 x 800 / 1030 x 25 (W x D x H)	<b>Melamin white, chipboard*</b> straight edge, for data connection panel with frame	T: 11256	1.635 Euro
	Table leg with base plate, black	<b>Fenix white, table top in MDF</b> chamfered edge, data connection panel frameless possible	T: 11261	2.375 Euro
		<b>Fenix black, table top in MDF</b> chamfered edge, data connection panel frameless possible	T: 11265	2.375 Euro

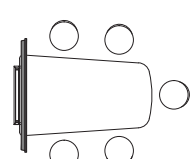
W6 Add-on table 160 for up to 5 people, sitting	Type / Design Dimension in mm	Color / Surface	Item number	Sales price
	Trapezium shape with rounded edges 1680 x 800 / 1030 x 25 (W x D x H)	<b>Melamin white, chipboard*</b> straight edge, for data connection panel with frame	T: 11258	1.950 Euro
	Table leg with base plate, black	<b>Fenix white, table top in MDF</b> chamfered edge, data connection panel frameless possible	T: 11262	2.905 Euro
		<b>Fenix black, table top in MDF</b> chamfered edge, data connection panel frameless possible	T: 11266	2.905 Euro

<b>Shipping within Europe</b>	Delivery of 1-3 pieces per pallet (further units = same price)	11278	390 Euro
-------------------------------	---	-------	----------

<b>Delivery and instalation</b>	on request
---------------------------------	------------

Optionen	Surface / Color	Item number	Sales price
<b>L-Foot</b> for free positioning on a wall, dimensions 740 x 305 mm (W x D)	metal, powder coated, black	10076	590 Euro
<b>T-Foot</b> for free positioning in a room, dimensions 740 x 410 mm (W x D)	metal, powder coated, black	10077	690 Euro

Prices = net sales prices, excluding VAT (in Euro)

\*Delivery time for melamin table tops, as well as tabletops with cutouts, is about 8 weeks.

Holzmedia GmbH

# UC-Display column\_W6 L (usually available from stock on short notice!)

for 70" to 80" displays  
with up to 60 kg weight

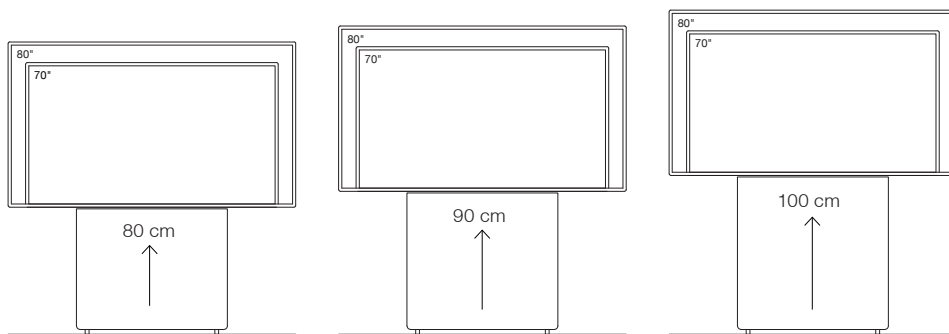

**Type / Design**

Housing and front cover made of MDF, finished with structure lacquer.  
For variable height display mounting/-positioning. Display mount not included.

Base furniture with plate height	80 cm	90 cm	100 cm
<b>Dimensions (W x D x H)</b>			
Furniture, outside	950 x 180 x 1650 - 1950 mm	950 x 180 x 1650 - 1950 mm	950 x 180 x 1650 - 1950 mm
Technology housing	750 x 140 x 760 mm	750 x 140 x 860 mm	750 x 140 x 960 mm
<b>Requirements for display integration</b>	1900 mm	1900 mm	1900 mm
- max. display width	60 kg	60 kg	60 kg
- max. display weight	120 - 130 mm	120 - 130 mm	120 - 130 mm
- recomm. display depth (incl. mount)	745 x 620 mm	745 x 620 mm	745 x 620 mm
- space for display mount (W x H)			
<b>Color / Item number</b>			
<b>arctic white</b>	<b>10612</b>	<b>10613</b>	<b>10614</b>
<b>basis rate for 1 piece</b>	<b>2.110 Euro</b>	<b>2.185 Euro</b>	<b>2.260 Euro</b>
<b>lava black</b>	<b>10620</b>	<b>10621</b>	<b>10622</b>
<b>basis rate for 1 piece</b>	<b>2.110 Euro</b>	<b>2.185 Euro</b>	<b>2.260 Euro</b>
excluding transportation (order of 3 more = scaled conditions!)	on request	on request	on request
<b>Shipping within Europe</b>	Delivery of 1-4 pieces per pallet (further units = same price)	12029	<b>390 Euro</b>
<b>Delivery and instalation</b>		on request	

Options	Surface / Color	Item number	Sales price
<b>Dual display board L<sup>2</sup></b> - for 2 x 70" to 80" displays, dimensions 2600 x 670 mm (W x D) Can only be used with wall attachment!	black MDF, clearly structure lacquered	10866	1.390 Euro
<b>VC camera mount</b> - for position over display, space 240 x 165 mm (W x D) - for position below display, in front of corresponding bezel plate L (10915 / 10916), space 300 x 240 mm (W x D)	metal, powder coated, black	10033	220 Euro
	metal, powder coated, black	10919	220 Euro
<b>L-Foot</b> for free positioning on a wall, dimensions 840 x 335 mm (W x D)	metal, powder coated, black	10616	690 Euro
<b>T-Foot</b> for free positioning in a room, dimensions 840 x 460 mm (W x D)	metal, powder coated, black	10617	840 Euro

## + complementary bezel plates - size L

for the integration of UC-systems / VC-cameras as well as control panels and connector panels

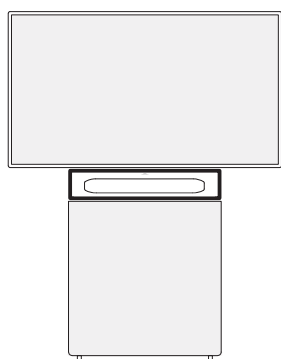

Type / Design

Made of MDF, finished with structure lacquer. In width of 95 cm.

### Universal

without cutout\*

#### Height 10 cm

arctic white lava black



Item number

10623 10634

Base price for 1 unit\*\*\*

220 Euro 220 Euro

#### Height 20 cm

arctic white lava black

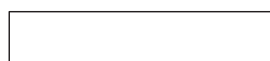

10626 10637

275 Euro 275 Euro

#### Height 30 cm\*\*

arctic white lava black



10630 10641

330 Euro 330 Euro

### Special - height 20 cm:

... for POLY STUDIO

Set, incl. mounting device

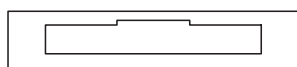

Item number

10859 10860

Base price for 1 unit\*\*\*

390 Euro 390 Euro

... for POLY X50 / X52 / V52

Set, incl. mounting device

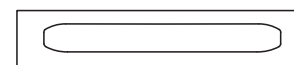

Item number

10731 10736

Base price for 1 unit\*\*\*

390 Euro 390 Euro

... for Logitech Rally Bar Mini

Set, incl. mounting device

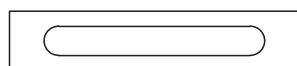

Item number

11316 11317

Base price for 1 unit\*\*\*

390 Euro 390 Euro

... for Yealink Smart Vision 40 new

Set, incl. mounting device

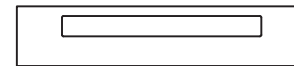

Item number

12310 12311

Base price for 1 unit\*\*\*

390 Euro 390 Euro

... for Sennheiser TC Bar M new

Set, incl. mounting device

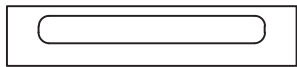

Item number

12521 12522

Base price for 1 unit\*\*\*

390 Euro 390 Euro

... for Jabra PanaCast 50

Set, incl. mounting device

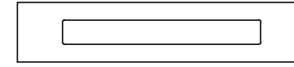

Item number

11217 11218

Base price for 1 unit\*\*\*

390 Euro 390 Euro

Universal UC body

for VC bars up to 670 x 140 x 120 mm

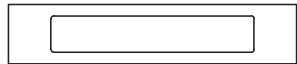

Item number

11399 11400

Base price for 1 unit\*\*\*

390 Euro 390 Euro

Universal bezel

with tray and cable outlet,  
for example for Lenovo Think Smart

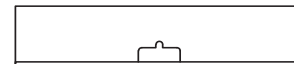

Item number

11213 11214

Base price for 1 unit\*\*\*

390 Euro 390 Euro

... for mount VC camera

(exclusive mount 10919)



Item number

10915 10916

Base price for 1 unit\*\*\*

330 Euro 330 Euro

Universal mounting device

without bezel, with depth compensation  
for systems wider than 95 cm

MDF, black

Item number

11405

Base price for 1 unit\*\*\*

90 Euro

Shipping within Europe

10649

35 Euro

\* Custom cutouts / drilled holes [from 10 pieces](#) on request possible.

\*\* Can be used in combination with 80 cm and 90 cm high front panel (the height of the lower edge of the display in this case is max. 120 cm).

\*\*\* plus transport/delivery | order of 3 or more = scaled conditions

## Media column\_W8 M

for 55" to 65" displays  
with up to 60 kg weight

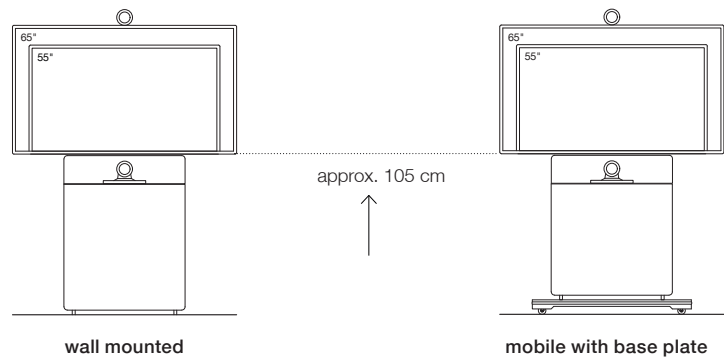

### VC camera position:

above display (height variable from 180 cm upward)  
or below display (height about 85 cm)

### Type / Design

One door – with textile cover for external speakers in black.  
Housing and door made of MDF, finished with structure lacquer.  
Passive housing ventilation for individual technology integration.  
Prepared for the integration of a video conference system. Display mount not included.

### Dimensions (W x D x H)

Furniture, outside (base plate)	800 x 220 x 1750 mm	800 (1050) x 220 (550) x 1750 (100) mm
Technology housing (*fittings not included)	650 x 180* x 800 mm	650 x 180* x 720 mm
Speaker housing	620 x 180 x 165 mm	620 x 180 x 165 mm

### Requirements for display integration

- max. display width	1600 mm	1600 mm
- max. display weight	60 kg	60 kg
- recom. display depth (incl. mount)	80 - 100 mm	80 - 100 mm
- space for display mount (W x H)	700 x 660 mm	700 x 660 mm
- recess for display and mount	80 mm	80 mm
- height of the display's lower edge	1050 mm	1050 mm

### Color\*\* / Item number

arctic white	10010	10012
lava black	10011	10013

### Base price for 1 unit

excluding transportation	3.210 Euro	4.220 Euro
(order of 3 or more = scaled conditions!)	on request	on request

### Shipping

on request

Options	Surface / Color	Item number	Sales price
<b>VC camera mount</b>			
- for position above display, space 240 x 165 mm (W x D)	metal, powder coated, black	10033	220 Euro
- for position in front and with adapted speaker fabric panel space 250 x 200 mm (W x D)	metal, powder coated, black	10034	220 Euro
<b>Customized bezel for VC systems up to a width of 620 mm</b>			
for Example for Cisco Webex Room Kit Mini / Poly X30/R30 / etc. incl. mounting device This bezel replaces the speaker covers of the main product.	structure lacquer arctic white	10571	445 Euro
	structure lacquer lava black	10704	445 Euro
<b>Door lock (per door/piece)</b>	nickel-plated, matt	10035	170 Euro
<b>Shelf for technology housing</b>			
	structured lacquer arctic white	10028	55 Euro
	structured lacquer lava black	10664	55 Euro
<b>Cable roll holder</b>			
on the back side of the mobile version	structure lacquer arctic white	10036	160 Euro
	structure lacquer lava black	10665	160 Euro



## Media column\_W8 L

for 70" to 80" displays  
with up to 80 kg weight

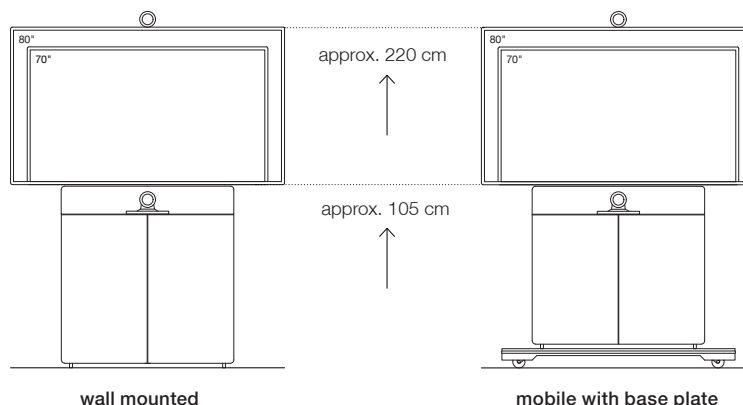

### VC camera position:

above display (height variable from 210 cm upward)  
or below display (height about 102 cm)

### Type / Design

Two doors – with textile cover for external speakers in black.  
Housing and door made of MDF, finished with structure lacquer.  
Passive housing ventilation for individual technology integration.  
Prepared for the integration of a video conference system. Display mount not included.

### Dimensions (W x D x H)

Furniture, outside (base plate)	1140 x 250 x 1960 mm	1140 (1540) x 250 (650) x 1960 (130) mm
Technology housing (*fittings not included)	2 x 480 x 210* x 950 mm	2 x 480 x 210* x 840 mm
Speaker housing	960 x 210 x 165 mm	960 x 210 x 165 mm

### Requirements for display integration

- max. display width	1900 mm	1900 mm
- max. display weight	80 kg	80 kg
- recom. display depth (incl. mount)	110 - 130 mm	110 - 130 mm
- space for display mount (W x H)	1040 x 725 mm	1040 x 725 mm
- recess for display and mount	110 mm	110 mm
- height of the display's lower edge	1200 mm	1200 mm

### Color\*\* / Item number

arctic white	10014	10016
lava black	10015	10017

### Base price for 1 unit

4.190 Euro

5.660 Euro

excluding transportation

(order of 3 or more = scaled conditions!)

on request

on request

### Shipping

on request

Options	Surface / Color	Item number	Sales price
<b>VC camera housing below display***</b>			
with centrally divided speaker cover, dimensions 340 x 210 x 180 mm (W x D x H)	structure lacquer arctic white	10667 ***12048	445 Euro
*** = wide version (540 x 210 x 180 mm), for dual cameras	structure lacquer lava black	10671 ***12049	445 Euro
<b>VC camera mount</b>			
- for position above display, space 240 x 165 mm (W x D)	metal, powder coated, black	10033	220 Euro
<b>Customized bezel for VC systems up to a width of 960 mm</b>			
for Example for Cisco Webex Room Kit (Plus) / PanaCast 50 / Polycom Studio / etc.	structure lacquer arctic white	10705	445 Euro
incl. mounting device	structure lacquer lava black	10706	445 Euro
This bezel replaces the speaker covers of the main product.			
<b>Door lock (per door/piece)</b>	nickel-plated, matt	10035	170 Euro
<b>Shelf for technology housing</b>			
	structure lacquer arctic white	10029	55 Euro
	structure lacquer lava black	10666	55 Euro
<b>Cable roll holder</b>			
on the back side of the mobile version	structure lacquer arctic white	10036	160 Euro
	structure lacquer lava black	10665	160 Euro

## Media column\_W8 XL

for 84" to 98" displays (16:9)  
with up to 100 kg weight

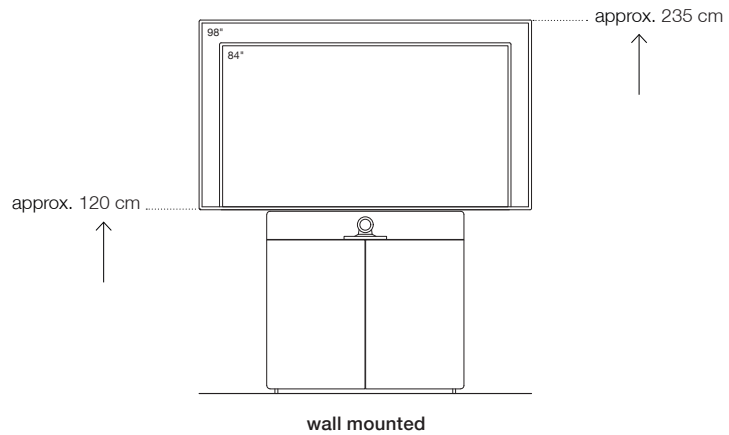

### VC camera position:

below display (height about 102 cm)

### Type / Design

Two doors – with textile cover for external speakers in black.  
Housing and door made of MDF, finished with structure lacquer.  
Passive housing ventilation for individual technology integration.  
Prepared for the integration of a video conference system. Display mount not included.

### Dimensions (W x D x H)

Furniture, outside (base plate)	1300 x 280 x 2070 mm
Technology housing (*fittings not included)	2 x 560 x 240* x 950 mm
Speaker housing	1120 x 240 x 165 mm

### Requirements for display integration

- max. display width	2280 mm
- max. display weight	100 kg
- recom. display depth (incl. mount)	130 - 150 mm
- space for display mount (W x H)	1200 x 835 mm
- recess for display and mount	130 mm
- height of the display's lower edge	1200 mm

### Color\*\* / Item number

arctic white	10018
lava black	10019

### Base price for 1 unit

excluding transportation	4.960 Euro
(order of 3 or more = scaled conditions!)	on request

### Shipping

on request

Options	Surface / Color	Item number	Sales price
<b>VC camera housing below display*/***</b> with centrally divided speaker cover, dimensions 340 x 210 x 180 mm (W x D x H) * = narrow version (180 x 240 x 180 mm), for Example for Rally Plus *** = wide version (540 x 240 x 180 mm), for dual cameras	structure lacquer arctic white	10668 *10692 ***11441	445 Euro
	structure lacquer lava black	10669 *10647 ***11442	445 Euro
<b>Customized bezel for VC systems up to a width of 1120 mm</b> for Example for Cisco Webex Room Kit (Plus) / Crestron Flex / Polycom Studio / etc. incl. mounting device This bezel replaces the speaker covers of the main product.	structure lacquer arctic white	10707	445 Euro
	structure lacquer lava black	10708	445 Euro
<b>Door lock (per door/piece)</b>	nickel-plated, matt	10035	170 Euro
<b>Shelf for technology housing</b>	structure lacquer arctic white	10030	55 Euro
	structure lacquer lava black	10670	55 Euro

## Media column\_W8 XL

for 84" to 98" displays (16:9)  
with up to 100 kg weight

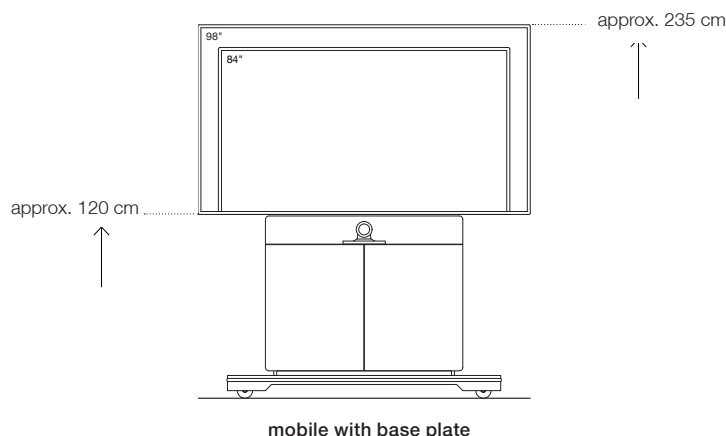

### VC camera position:

below display (height about 102 cm)

### Type / Design

Two doors – with textile cover for external speakers in black.  
Housing and door made of MDF, finished with structure lacquer.  
Passive housing ventilation for individual technology integration.  
Prepared for the integration of a video conference system. Display mount not included.

### Dimensions (W x D x H)

Furniture, outside (base plate)	1300 (1800) x 280 (700) x 2070 (150) mm
Technology housing (*fittings not included)	2 x 560 x 240* x 820 mm
Speaker housing	1120 x 240 x 165 mm

### Requirements for display integration

- max. display width	2280 mm
- max. display weight	100 kg
- recom. display depth (incl. mount)	130 - 150 mm
- space for display mount (W x H)	1200 x 835 mm
- recess for display and mount	130 mm
- height of the display's lower edge	1200 mm

### Color\*\* / Item number

arctic white	<b>10020</b>
lava black	<b>10021</b>

### Base price for 1 unit

excluding transportation	<b>6.965 Euro</b>
(order of 3 or more = scaled conditions!)	on request

### Shipping

on request

Options	Surface / Color	Item number	Sales price
<b>VC camera housing below display*/***</b> with centrally divided speaker cover, dimensions 340 x 240 x 180 mm (W x D x H) * = narrow version (180 x 240 x 180 mm), for Example for Rally Plus *** = wide version (540 x 240 x 180 mm), for dual cameras	structure lacquer arctic white	10668 *10692 ***11441	445 Euro
	structure lacquer lava black	10669 *10647 ***11442	445 Euro
<b>Customized bezel for VC systems up to a width width of 1120 mm</b> for Example for Cisco Webex Room Kit (Plus) / Crestron Flex / Polycom Studio / etc. incl. mounting device This bezel replaces the speaker covers of the main product.	structure lacquer arctic white	10707	445 Euro
	structure lacquer lava black	10708	445 Euro
<b>Door lock (per door/piece)</b>	nickel-plated, matt	10035	170 Euro
<b>Shelf for technology housing</b>	structure lacquer arctic white	10030	55 Euro
	structure lacquer lava black	10670	55 Euro
<b>Cable roll holder</b> on the back side	structure lacquer arctic white	10036	160 Euro
	structure lacquer lava black	10665	160 Euro

## Media column\_W8 XXL

for 100" to 110" displays and LED panels  
 also in 21:9 format  
 with each up to 120 kg weight

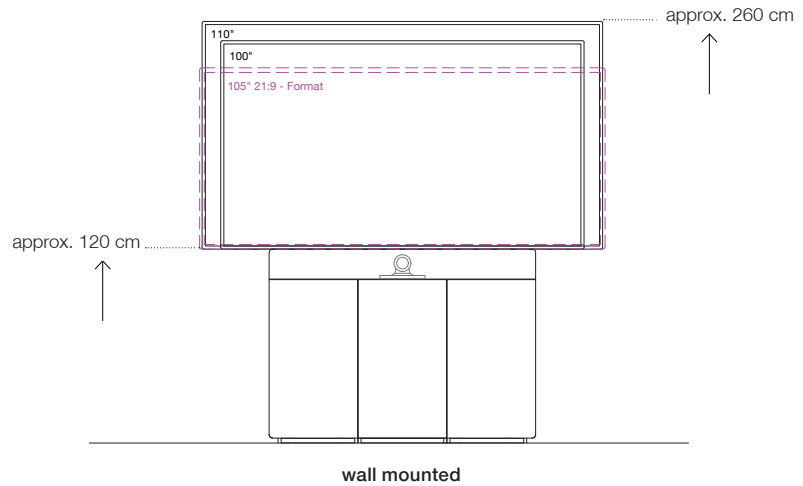

### VC camera position:

below display (height about 102 cm)

### Type / Design

Three doors – with textile cover for external speakers in black.  
 Housing and door made of MDF, finished with structure lacquer.  
 Passive housing ventilation for individual technology integration.  
 Prepared for the integration of a video conference system. Display mount not included.

### Dimensions (W x D x H)

Furniture, outside (base plate)	1680 x 310 x 2210 mm
Technology housing (*fittings not included)	2 x 460 x 270* x 950 mm 1 x 520 x 270* x 950 mm
Speaker housing	2 x 430 x 270 x 165 mm

### Requirements for display integration

- max. display width	2500 mm
- max. display weight	120 kg
- recom. display depth (incl. mount)	130 - 150 mm
- space for display mount (W x H)	1580 x 975 mm
- recess for display and mount	130 mm
- height of the display's lower edge	1200 mm

### Color\*\* / Item number

arctic white	11526
lava black	11527

### Base price for 1 unit

excluding transportation	7.870 Euro
(order of 3 or more = scaled conditions!)	on request

### Shipping

on request

Options	Surface / Color	Item number	Sales price
<b>VC camera housing below display***</b> with centrally divided speaker cover, dimensions 340 x 270 x 180 mm (W x D x H) *** = wide version (540 x 270 x 180 mm), for dual cameras	structure lacquer arctic white	11530 ***11943	445 Euro
	structure lacquer lava black	11531 ***11944	445 Euro
<b>Customized bezel for VC systems</b> for Example for Cisco Webex Room Kit (Plus) / Crestron Flex / Polycom Studio / etc. incl. mounting device This bezel replaces the speaker covers of the main product.	structure lacquer arctic white	11532	445 Euro
	structure lacquer lava black	11533	445 Euro
<b>Door lock (per door/piece)</b>	nickel-plated, matt	10035	170 Euro
<b>Shelf for technology housing</b>	structure lacquer arctic white	each L/R:11534, M:11535	55 Euro
	structure lacquer lava black	each L/R:11536, M:11537	55 Euro
<b>Individual adjustment/enlargement of the display mounting board for LED panels</b>	structure lacquer arctic white	12033	490 Euro

## Media column\_W8 XXL

for 100" to 110" displays and LED panels  
 also in 21:9 format  
 with each up to 120 kg weight

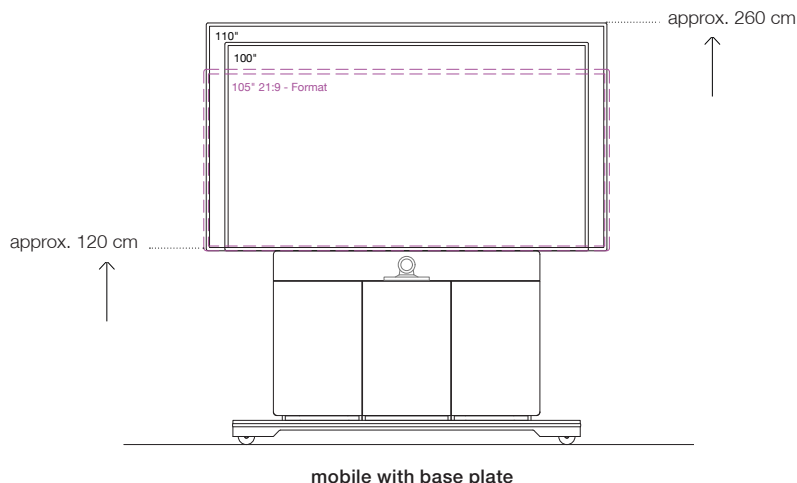

### VC camera position:

below display (height about 102 cm).

### Type / Design

Three doors – with textile cover for external speakers in black.  
 Housing and door made of MDF, finished with structure lacquer.  
 Passive housing ventilation for individual technology integration.  
 Prepared for the integration of a video conference system. Display mount not included.

### Dimensions (W x D x H)

Furniture, outside (base plate)

1680 (2150) x 310 (750) x 2210 (150) mm

Technology housing (\*fittings not included)

2 x 460 x 270\* x 820 mm

1 x 520 x 270\* x 820 mm

Speaker housing

2 x 430 x 270 x 165 mm

### Requirements for display integration

- max. display width	2500 mm
- max. display weight	120 kg
- recom. display depth (incl. mount)	130 - 150 mm
- space for display mount (W x H)	1580 x 975 mm
- recess for display and mount	130 mm
- height of the display's lower edge	1200 mm

### Color\*\* / Item number

arctic white

**11528**

lava black

**11529**

### Base price for 1 unit

**10.880 Euro**

excluding transportation

(order of 3 or more = scaled conditions!)

on request

### Shipping

on request

Options	Surface / Color	Item number	Sales price
<b>VC camera housing below display***</b> with centrally divided speaker cover, dimensions 340 x 270 x 180 mm (W x D x H) *** = wide version (540 x 270 x 180 mm), for dual cameras	structure lacquer arctic white	11530 ***11943	445 Euro
	structure lacquer lava black	11531 ***11944	445 Euro
<b>Customized bezel for VC systems</b> for Example for Cisco Webex Room Kit (Plus) / Crestron Flex / Polycom Studio / etc. incl. mounting device This bezel replaces the speaker covers of the main product.	structure lacquer arctic white	11532	445 Euro
	structure lacquer lava black	11533	445 Euro
<b>Door lock (per door/piece)</b>	nickel-plated, matt	10035	170 Euro
<b>Shelf for technology housing</b>	structure lacquer arctic white	each L/R:11534, M:11535	55 Euro
	structure lacquer lava black	each L/R:11536, M:11537	55 Euro
<b>Individual adjustment/enlargement of the display mounting board for LED panels</b>	structure lacquer lava black	12033	290 Euro
<b>Cable roll holder</b> on the back side	structure lacquer arctic white	10036	160 Euro
	structure lacquer lava black	10665	160 Euro

# Media column\_W8 M<sup>2</sup>

for 55" to 65" displays  
with each up to 60 kg weight

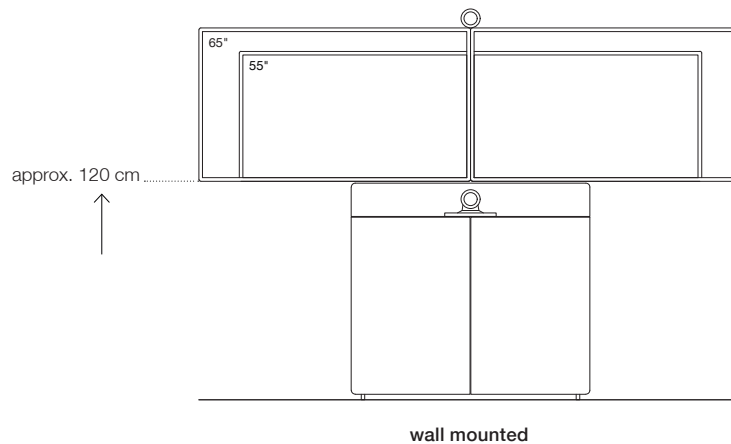

## VC camera position:

above display (height variable from 195 cm upward)  
or below display (height about 102 cm)

## Type / Design

Two doors – with textile cover for external speakers in black.  
Housing and door made of MDF, finished with structure lacquer.  
Passive housing ventilation for individual technology integration.  
Prepared for the integration of a video conference system. Display mount not included.

## Dimensions (W x D x H)

Furniture, outside (base plate)	1300 x 280 x 1900 mm
Technology housing (*fittings not included)	2 x 560 x 240* x 950 mm
Speaker housing	1120 x 240 x 165 mm

## Requirements for display integration

- max. display width	1600 mm
- max. display weight	60 kg
- recom. display depth (incl. mount)	80 - 100 mm
- space for display mount (W x H)	2200 x 660 mm
- recess for display and mount	80 mm
- height of the display's lower edge	1200 mm

## Color\*\* / Item number

arctic white	10022
lava black	10023

## Base price for 1 unit

excluding transportation	5.290 Euro
(order of 3 or more = scaled conditions!)	on request

## Shipping

on request

Options	Surface / Color	Item number	Sales price
<b>VC camera housing below display*/***</b> with centrally divided speaker cover, dimensions 340 x 240 x 180 mm (W x D x H) * = narrow version (180 x 240 x 180 mm), for Example for Rally Plus *** = wide version (540 x 240 x 180 mm), for dual cameras	structure lacquer arctic white	10672 *10678 ***11443	445 Euro
	structure lacquer lava black	10673 *10720 ***11444	445 Euro
<b>VC camera mount</b> for position in front of speaker cover, space 240 x 165 mm (W x D)	metal, powder coated, black	10033	220 Euro
<b>Customized bezel for VC systems up to a width of 1120 mm</b> for Example for Cisco Webex Room Kit (Plus) / Crestron Flex / Polycom Studio / etc. incl. mounting device This bezel replaces the speaker covers of the main product.	structure lacquer arctic white	10709	445 Euro
	structure lacquer lava black	10710	445 Euro
<b>Door lock (per door/piece)</b>	nickel-plated, matt	10035	170 Euro
<b>Shelf for technology housing</b>	structure lacquer arctic white	10031	55 Euro
	structure lacquer lava black	10674	55 Euro

# Medienstele\_W8 M<sup>2</sup>

for 55" to 65" displays  
with each up to 60 kg weight

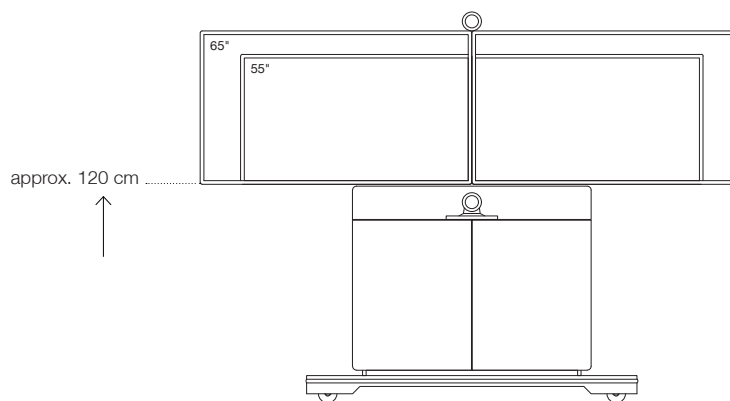

mobile with base plate

## Type / Design

Two doors – with textile cover for external speakers in black.  
Housing and door made of MDF, finished with structure lacquer.  
Passive housing ventilation for individual technology integration.  
Prepared for the integration of a video conference system. Display mount not included.

## Dimensions (W x D x H)

Furniture, outside (base plate)	1300 (1800) x 280 (700) x 1900 (150) mm
Technology housing (*fittings not included)	2 x 560 x 240* x 820 mm
Speaker housing	1120 x 240 x 165 mm

## Requirements for display integration

- max. display width	1600 mm
- max. display weight	60 kg
- recom. display depth (incl. mount)	80 - 100 mm
- space for display mount (W x H)	2200 x 660 mm
- recess for display and mount	80 mm
- height of the display's lower edge	1200 mm

## Color\*\* / Item number

arctic white	10024
lava black	10025

## Base price for 1 unit

excluding transportation	7.295 Euro
(order of 3 or more = scaled conditions!)	on request

## Shipping

on request

Options	Surface / Color	Item number	Sales price
<b>VC camera housing below display*/***</b> with centrally divided speaker cover, dimensions 340 x 240 x 180 mm (W x D x H) * = narrow version (180 x 240 x 180 mm), for Example for Rally Plus *** = wide version (540 x 240 x 180 mm), for dual cameras	structure lacquer arctic white	10672 * 10678 *** 11443	445 Euro
	structure lacquer lava black	10673 * 10720 *** 11444	445 Euro
<b>VC camera mount</b> for position in front of speaker cover, space 240 x 165 mm (W x D)	metal, powder coated, black	10033	220 Euro
<b>Customized bezel for VC systems up to a width of 1120 mm</b> for Example for Cisco Webex Room Kit (Plus) / Crestron Flex / Polycom Studio / etc. incl. mounting device This bezel replaces the speaker covers of the main product.	structure lacquer arctic white	10709	445 Euro
	structure lacquer lava black	10710	445 Euro
<b>Door lock (per door/piece)</b>	nickel-plated, matt	10035	170 Euro
<b>Shelf for technology housing</b>	structure lacquer arctic white	10031	55 Euro
	structure lacquer lava black	10674	55 Euro
<b>Cable roll holder</b> on the back side	structure lacquer arctic white	10036	160 Euro
	structure lacquer lava black	10665	160 Euro

# Media column\_W8 L<sup>2</sup>

for 70" to 80" displays  
with each up to 80 kg weight

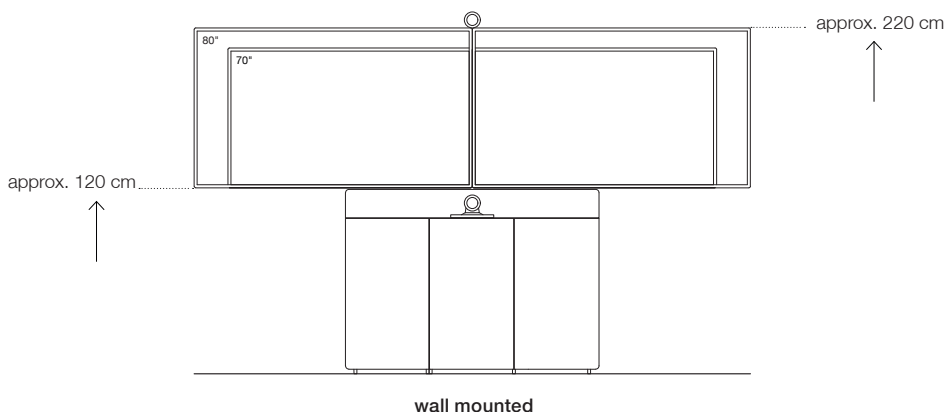

**VC camera position:**

above display (height variable from 210 cm upward) or below display (height about 102 cm)

**Type / Design**

Three doors – with textile cover for external speakers in black.  
Housing and door made of MDF, finished with structure lacquer.  
Passive housing ventilation for individual technology integration.  
Prepared for the integration of a video conference system. Display mount not included.

**Dimensions (W x D x H)**

Furniture, outside (base plate)	1680 x 310 x 1960 mm
Technology housing (*fittings not included)	2 x 460 x 270* x 950 mm 1 x 520 x 270* x 950 mm
Speaker housing	2 x 430 x 270 x 165 mm

**Requirements for display integration**

- max. display width	1900 mm
- max. display weight	80 kg
- recom. display depth (incl. mount)	110 - 130 mm
- space for display mount (W x H)	2850 x 725 mm
- recess for display and mount	110 mm
- height of the display's lower edge	1200 mm

**Color\*\* / Item number**

arctic white	10026
lava black	10027

**Base price for 1 unit**

excluding transportation	6.940 Euro
(order of 3 or more = scaled conditions!)	on request

**Shipping**

on request

Options	Surface / Color	Item number	Sales price
<b>VC camera housing below display***</b> with centrally divided speaker cover, dimensions 340 x 270 x 180 mm (W x D x H) *** = wide version (540 x 270 x 180 mm), for dual cameras	structure lacquer arctic white	10675 ***11445	445 Euro
	structure lacquer lava black	10676 ***11446	445 Euro
<b>VC camera mount</b> for position in front of speaker cover, space 240 x 165 mm (W x D)	metal, powder coated, black	10033	220 Euro
<b>Customized bezel for VC systems</b> for Example for Cisco Webex Room Kit (Plus) / Crestron Flex / Polycom Studio / etc. incl. mounting device This bezel replaces the speaker covers of the main product.	structure lacquer arctic white	10711	445 Euro
	structure lacquer lava black	10712	445 Euro
<b>Door lock (per door/piece)</b>	nickel-plated, matt	10035	170 Euro
<b>Shelf for technology housing</b>	structure lacquer arctic white	each L/R:10032, M:10682	55 Euro
	structure lacquer lava black	each L/R:10677, M:10684	55 Euro

\*\* Structure lacquer colors can be customized on request against surcharge.  
Prices = net sales prices, excluding VAT (in Euro)



## Media column\_W8 L<sup>2</sup>

for 70" to 80" displays  
with each up to 80 kg weight

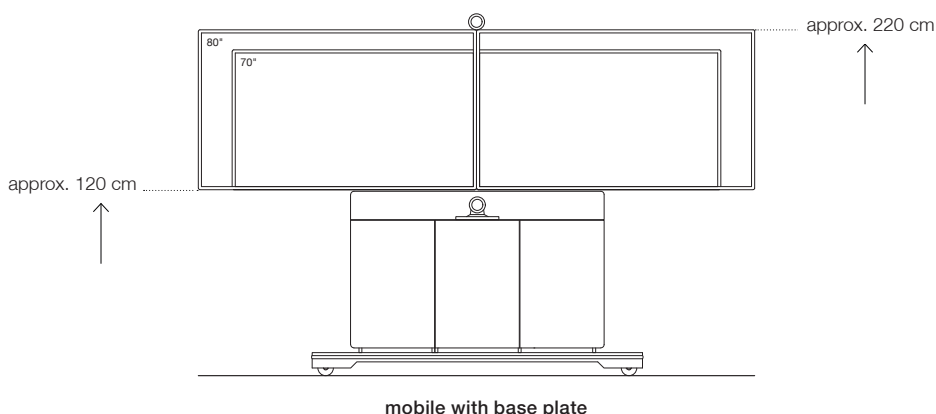

### VC camera position:

above display (height variable from 210 cm upward) or below display (height about 102 cm)

### Type / Design

Three doors – with textile cover for external speakers in black.  
Housing and door made of MDF, finished with structure lacquer.  
Passive housing ventilation for individual technology integration.  
Prepared for the integration of a video conference system. Display mount not included.

### Dimensions (W x D x H)

Furniture, outside (base plate)

1680 (2150) x 310 (700) x 1960 (150) mm

Technology housing (\*fittings not included)

2 x 460 x 270\* x 820 mm

1 x 520 x 270\* x 820 mm

Speaker housing

2 x 430 x 270 x 165 mm

### Requirements for display integration

- max. display width	1900 mm
- max. display weight	80 kg
- recom. display depth (incl. mount)	110 - 130 mm
- space for display mount (W x H)	2850 x 725 mm
- recess for display and mount	110 mm
- height of the display's lower edge	1200 mm

### Color\*\* / Item number

arctic white	10651
lava black	10652

### Base price for 1 unit

**9.670 Euro**

excluding transportation

(order of 3 or more = scaled conditions!)

on request

### Shipping

on request

Options	Surface / Color	Item number	Sales price
<b>VC camera housing below display***</b> with centrally divided speaker cover, dimensions 340 x 270 x 180 mm (W x D x H) *** = wide version (540 x 270 x 180 mm), for dual cameras	structure lacquer arctic white	10675 ***11445	445 Euro
	structure lacquer lava black	10676 ***11446	445 Euro
<b>VC camera mount</b> for position in front of speaker cover, space 240 x 165 mm (W x D)	metal, powder coated, black	10033	220 Euro
<b>Customized bezel for VC systems</b> for Example for Cisco Webex Room Kit (Plus) / Crestron Flex / Polycom Studio / etc. incl. mounting device This bezel replaces the speaker covers of the main product.	structure lacquer arctic white	10711	445 Euro
	structure lacquer lava black	10712	445 Euro
<b>Door lock (per door/piece)</b>	nickel-plated, matt	10035	170 Euro
<b>Shelf for technology housing</b>	structure lacquer arctic white	each L/R:10032, M:10682	55 Euro
	structure lacquer lava black	each L/R:10677, M:10684	55 Euro
<b>Cable roll holder</b> on the back side	structure lacquer arctic white	10036	160 Euro
	structure lacquer lava black	10665	160 Euro

# Media column\_W8 XL<sup>2</sup>

for 84" to 98" displays (16:9)  
with each up to 100 kg weight

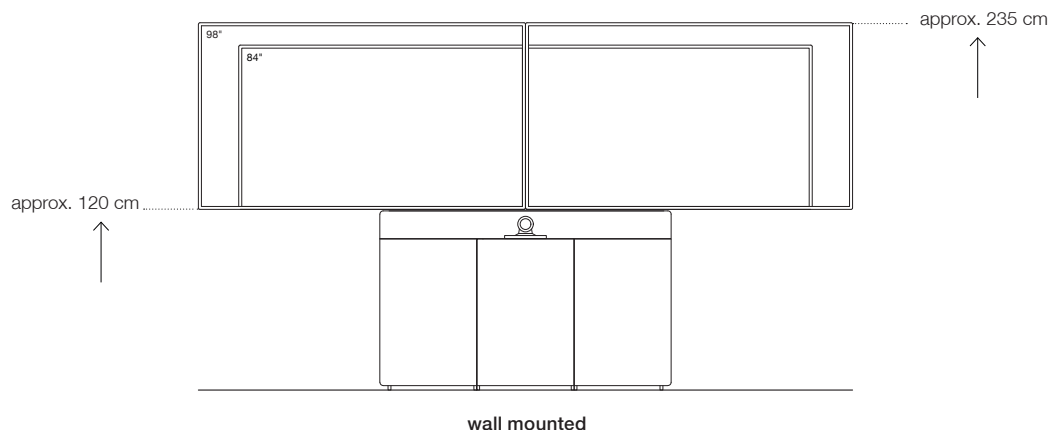

**VC camera position:**  
below display (height about 102 cm)

**Type / Design**

Three doors – with textile cover for external speakers in black.  
Housing and door made of MDF, finished with structure lacquer.  
Passive housing ventilation for individual technology integration.  
Prepared for the integration of a video conference system. Display mount not included.

**Dimensions (W x D x H)**

Furniture, outside (base plate)	1950 x 310 x 2070 mm
Technology housing (*fittings not included)	2 x 550 x 270* x 950 mm 1 x 610 x 270* x 950 mm
Speaker housing	2 x 520 x 270 x 165 mm

**Requirements for display integration**

- max. display width	2280 mm
- max. display weight	100 kg
- recom. display depth (incl. mount)	130 - 150 mm
- space for display mount (W x H)	3400 x 835 mm
- recess for display and mount	130 mm
- height of the display's lower edge	1200 mm

**Color\*\* / Item number**

arctic white	<b>10653</b>
lava black	<b>10654</b>

**Base price for 1 unit**

excluding transportation	<b>8.150 Euro</b>
(order of 3 or more = scaled conditions!)	on request

**Shipping**

on request

Options	Surface / Color	Item number	Sales price
<b>VC camera housing below display***</b> with centrally divided speaker cover, dimensions 340 x 270 x 180 mm (W x D x H) *** = wide version (540 x 270 x 180 mm), for dual cameras	structure lacquer arctic white	10679 ***11447	445 Euro
	structure lacquer lava black	10680 ***11448	445 Euro
<b>Customized bezel for VC systems</b> for Example for Cisco Webex Room Kit (Plus) / Crestron Flex / Polycom Studio / etc. incl. mounting device This bezel replaces the speaker covers of the main product.	structure lacquer arctic white	10713	445 Euro
	structure lacquer lava black	10714	445 Euro
<b>Door lock (per door/piece)</b>	nickel-plated, matt	10035	170 Euro
<b>Shelf for technology housing</b>	structure lacquer arctic white	each L/R:10681, M:10686	55 Euro
	structure lacquer lava black	each L/R:10687, M:10688	55 Euro

\*\* Structure lacquer colors can be customized on request against surcharge.  
Prices = net sales prices, excluding VAT (in Euro)

# Media column\_W8 XL<sup>2</sup>

for 84" to 98" displays (16:9)  
with each up to 100 kg weight

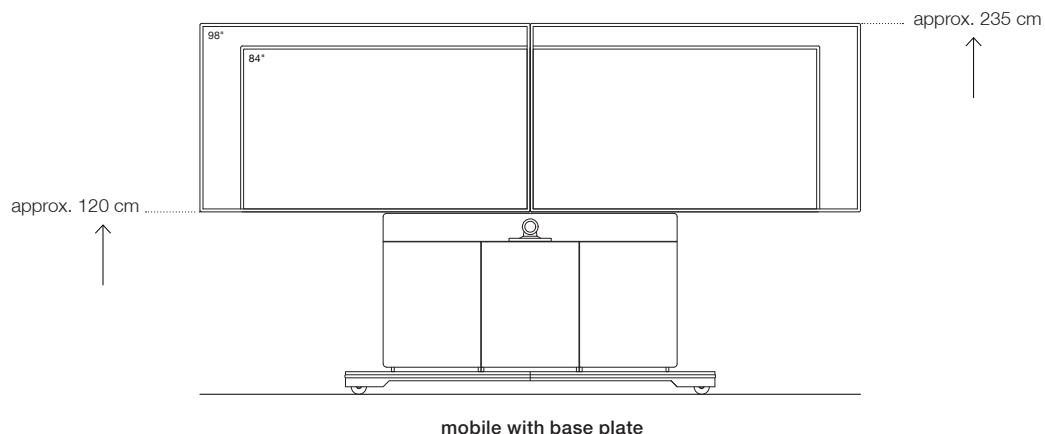

**VC camera position:**  
below display (height about 102 cm)

## Type / Design

Three doors – with textile cover for external speakers in black.  
Housing and door made of MDF, finished with structure lacquer.  
Passive housing ventilation for individual technology integration.  
Prepared for the integration of a video conference system. Display mount not included.

## Dimensions (W x D x H)

Furniture, outside (base plate)	1950 (2450) x 310 (750) x 2070 (150) mm
Technology housing (*fittings not included)	2 x 550 x 270* x 820 mm 1 x 610 x 270* x 820 mm
Speaker housing	2 x 520 x 270 x 165 mm

## Requirements for display integration

- max. display width	2280 mm
- max. display weight	100 kg
- recom. display depth (incl. mount)	130 - 150 mm
- space for display mount (W x H)	3400 x 835 mm
- recess for display and mount	130 mm
- height of the display's lower edge	1200 mm

## Color\*\* / Item number

arctic white	<b>10655</b>
lava black	<b>10656</b>

## Base price for 1 unit

excluding transportation	<b>11.090 Euro</b>
(order of 3 or more = scaled conditions!)	on request

## Shipping

on request

Options	Surface / Color	Item number	Sales price
<b>VC camera housing below display***</b> with centrally divided speaker cover, dimensions 340 x 270 x 180 mm (W x D x H) *** = wide version (540 x 270 x 180 mm), for dual cameras	structure lacquer arctic white	10679 ***11447	445 Euro
	structure lacquer lava black	10680 ***11448	445 Euro
<b>Customized bezel for VC systems</b> for Example for Cisco Webex Room Kit (Plus) / Crestron Flex / Polycom Studio / etc. incl. mounting device This bezel replaces the speaker covers of the main product.	structure lacquer arctic white	10713	445 Euro
	structure lacquer lava black	10714	445 Euro
<b>Door lock (per door/piece)</b>	nickel-plated, matt	10035	170 Euro
<b>Shelf for technology housing</b>	structure lacquer arctic white	each L/R:10681, M:10686	55 Euro
	structure lacquer lava black	each L/R:10687, M:10688	55 Euro
<b>Cable roll holder</b> on the back side	structure lacquer arctic white	10036	160 Euro
	structure lacquer lava black	10665	160 Euro

\*\* Structure lacquer colors can be customized on request against surcharge.  
Prices = net sales prices, excluding VAT (in Euro)



## Media furniture\_S1 M

height adjustable  
for 55" to 65" displays  
with up to 60 kg weight

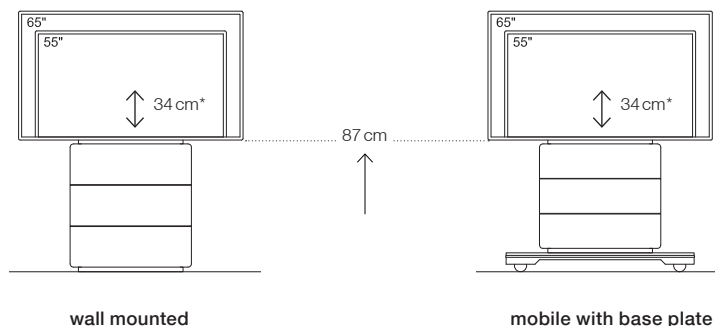

### Type / Design

One door - housing and door made of MDF, finished with structure lacquer.  
Passive housing ventilation for individual technology integration.  
Display mount not included.

### Dimensions (W x D x H)

Furniture, outside (base plate)	800 x 310 x 1630 mm	800 (1240) x 310 (650) x 1630 (130) mm
Technology housing (fittings not included)	650 x 170/270 x 750 mm	650 x 170/270 x 650 mm
Space for technical components (W x H)	2 x 255 x 750 mm	2 x 255 x 650 mm

### Requirements for display integration

- max. display width	1650 mm	1650 mm
- max. display weight	60 kg	60 kg
- recomm. display depth (incl. mount)	110 - 150 mm	110 - 150 mm
- space for display mount (W x H)	630 x 690 mm	630 x 690 mm
- recess for display and mount	110 mm	110 mm
- minimum display height	740 mm	740 mm

### Color\* / Item number

arctic white	<b>10043</b>	<b>10045</b>
lava black	<b>10044</b>	<b>10046</b>

### Base price for 1 unit

**5.260 Euro** **6.610 Euro**

excluding transportation

(order of 3 or more = scaled conditions!)

on request

on request

### Shipping

on request

Options	Surface / Color	Item number	Sales price
<b>VC camera mount</b>			
- for position above display, space 240 x 165 mm (W x D)	metal, powder coated, black	10033	220 Euro
- for position on the side of display for 55" to 98" adjustable, space 240 x 150 mm (W x D)	metal, powder coated, black	10657	445 Euro
<b>Installation adapter plate</b>			
for Cisco Webex Board 55"	structure lacquer arctic white	11422	200 Euro
	structure lacquer lava black	11421	200 Euro
<b>Door lock (per door/piece)</b>	nickel-plated, matt	10063	170 Euro
<b>Shelf for technology housing</b>			
	structure lacquer arctic white	10055	55 Euro
	structure lacquer lava black	10689	55 Euro
<b>Door with textile speaker cover</b>			
for external speakers, incl. shelf	structure lacquer arctic white, fabric black	10058	530 Euro
	structure lacquer lava black, fabric black	10690	530 Euro
<b>Cable roll holder</b>			
on the back side of the mobile version	structure lacquer arctic white	12034	160 Euro
	structure lacquer lava black	12035	160 Euro

## Media furniture\_S1 L

height adjustable  
for 70" to 80" displays  
with up to 100 kg weight

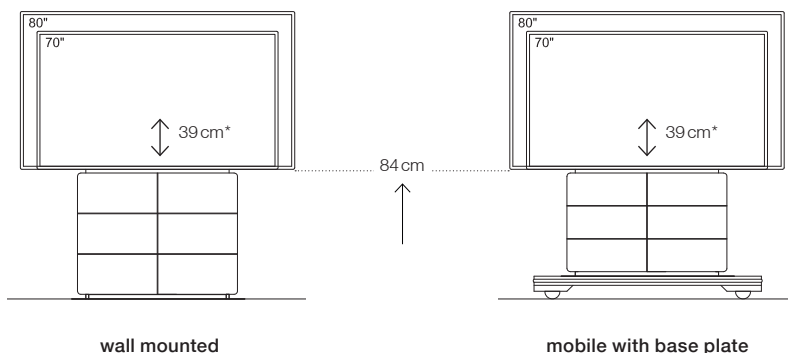

### Type / Design

Two doors - housing and door made of MDF, finished with structure lacquer.  
Passive housing ventilation for individual technology integration.  
Display mount not included.

### Dimensions (W x D x H)

Furniture, outside (base plate)	1060 x 320 x 1740 mm	1060 (1500) x 320 (700) x 1740 (150) mm
Technology housing (fittings not included)	2 x 440 x 180/280 x 745 mm	2 x 440 x 180/280 x 610 mm
Space for technical components (W x H)	465 x 745 mm	465 x 610 mm

### Requirements for display integration

- max. display width	1900 mm	1900 mm
- max. display weight	100 kg	100 kg
- recomm. display depth (incl. mount)	120 - 160 mm	120 - 160 mm
- space for display mount (W x H)	880 x 730 mm	880 x 730 mm
- recess for display and mount	120 mm	120 mm
- minimum display height	900 mm	900 mm

### Color\* / Item number

arctic white	10047	10049
lava black	10048	10050
		8.150 Euro

### Base price for 1 unit

excluding transportation	6.420 Euro	on request
(order of 3 or more = scaled conditions!)	on request	

### Shipping

on request

Options	Surface / Color	Item number	Sales price
<b>VC camera mount</b>			
- for position above display, space 240 x 165 mm (W x D)	metal, powder coated, black	10033	220 Euro
- for position on the side of display for 55" to 98" adjustable, space 240 x 150 mm (W x D)	metal, powder coated, black	10657	445 Euro
<b>Installation adapter plate</b>			
for Cisco Webex Board Pro 75"	structure lacquer arctic white	11420	255 Euro
	structure lacquer lava black	11419	255 Euro
<b>Door lock (per door/piece)</b>	nickel-plated, matt	10063	170 Euro
<b>Shelf for technology housing</b>			
	structure lacquer arctic white	10056	55 Euro
	structure lacquer lava black	10694	55 Euro
<b>Door with textile speaker cover</b>			
for external speakers, incl. shelf	structure lacquer arctic white, fabric black	10059	590 Euro
	structure lacquer lava black, fabric black	10695	590 Euro
<b>Cable roll holder</b>			
on the back side of the mobile version	structure lacquer arctic white	12034	160 Euro
	structure lacquer lava black	12035	160 Euro

## Media furniture\_S1 XL

height adjustable  
for 84" to 98" displays  
with up to 130 kg weight

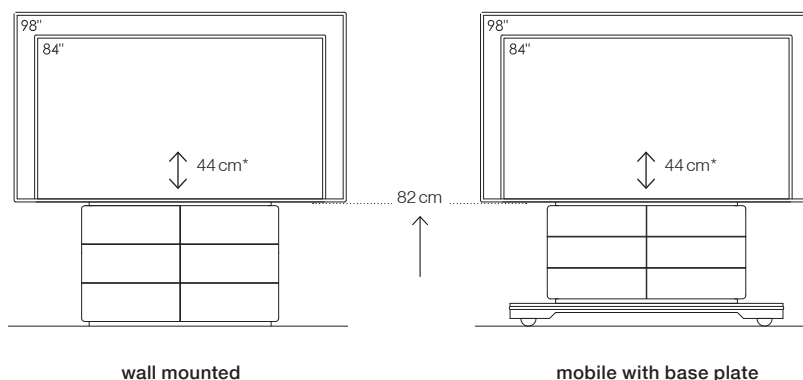

### Type / Design

Two doors - housing and door made of MDF, finished with structure lacquer.  
Passive housing ventilation for individual technology integration.  
Display mount not included.

### Dimensions (W x D x H)

Furniture, outside (base plate)

1310 x 330 x 1800 mm

1310 (1800) x 330 (750) x 1800 (150) mm

Technology housing (fittings not included)

2 x 570 x 190/290 x 710 mm

2 x 570 x 190/290 x 580 mm

Space for technical components (W x H)

720 x 710 mm

720 x 580 mm

### Requirements for display integration

- max. display width	2210 mm	2210 mm
- max. display weight	130 kg	130 kg
- recomm. display depth (incl. mount)	130 - 180 mm	130 - 180 mm
- space for display mount (W x H)	1140 x 770 mm	1140 x 770 mm
- recess for display and mount	130 mm	130 mm
- minimum display height	970 mm	970 mm

### Color\* / Item number

arctic white	10051	10053
lava black	10052	10054

### Base price for 1 unit

7.290 Euro

9.280 Euro

excluding transportation

(order of 3 or more = scaled conditions!)

on request

on request

### Shipping

on request

Options	Surface / Color	Item number	Sales price
<b>VC camera mount</b>			
- for position above display, space 240 x 165 mm (W x D)	metal, powder coated, black	10033	220 Euro
- for position on the side of display for 55" to 98" adjustable, space 240 x 150 mm (W x D)	metal, powder coated, black	10657	445 Euro
<b>Door lock (per door/piece)</b>	nickel-plated, matt	10063	170 Euro
<b>Shelf for technology housing</b>	structure lacquer arctic white	10057	55 Euro
	structure lacquer lava black	10697	55 Euro
<b>Door with textile speaker cover</b>	structure lacquer arctic white, fabric black	10060	720 Euro
for external speakers, incl. shelf	structure lacquer lava black, fabric black	10698	720 Euro
<b>Cable roll holder</b>	structure lacquer arctic white	12034	160 Euro
on the back side of the mobile version	structure lacquer lava black	12035	160 Euro

## LED-Media wall\_W9 - 110 (for 108" - 110" in 16 : 9 format)

### Base module

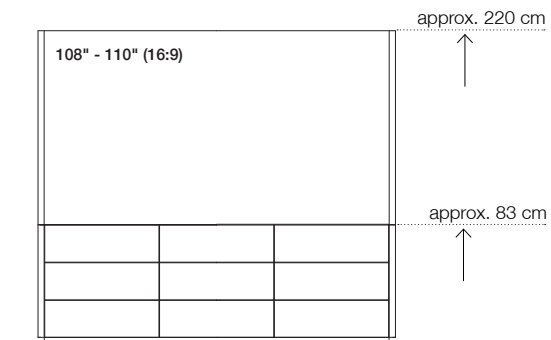

wall mounted, 3-door

#### Type / Design

Melamine housing, MDF doors and sides, finished with structure lacquer.  
With passive housing ventilation for individual technology integration.  
Prepared for the integration of LED screens.  
LED mount not included.

#### approx. Dimensions (W x D x H)

= individually adapted to LED screen

Furniture, outside

2530 x 320 x 2200 mm

Technology housing (\*fittings not included)

3 x 770 x 270 x 730 mm

Mounting surface for LED screens (W x H)

2450 x 1380 mm

#### Max. screen weight

180 kg

#### Color\*\* / Item number

arctic white

12343

lava black

12344

#### Base price for 1 unit

8.360 Euro

excluding transportation

(order of 3 more = scaled conditions!)

#### Shipping





on request

Options	Surface / Color	Item number	Sales price
<b>Outer doors with speaker panels in fabric</b> for external loud speaker includes shelf space for speakers approx. 730 x 220 mm (W x H) The technology compartments reduces accordingly.	structure lacquer arctic white, fabric black	11963	890 Euro
	structure lacquer lava black, fabric black	11964	890 Euro
<b>Door lock (per door/piece)</b>	nickel-plated, matt	12036	170 Euro
<b>Shelf for technology housing</b>	structure lacquer arctic white	11966	55 Euro
	structure lacquer lava black	11967	55 Euro
<b>VC camera mount</b> for lateral positioning on LED-Media wall W9 space: 240 x 150 mm (W x D)	metal, powder coated, black	L: 11968	445 Euro
		R: 12127	445 Euro

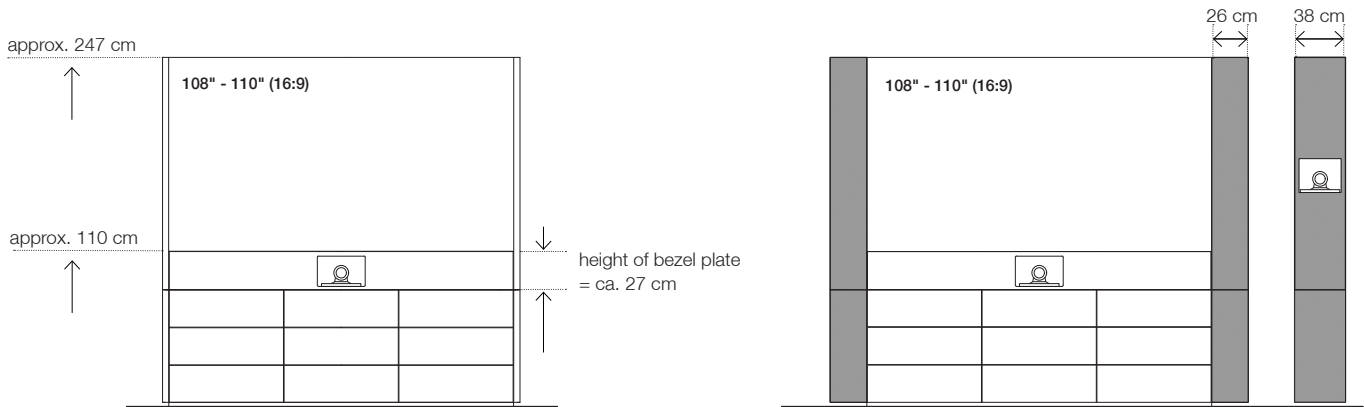

... optional ① with bezel plate for VC integration (can not be upgraded!)  
and / or ② with lateral speaker cabinets

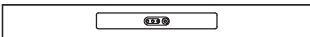

	approx. Size	Surface / Color	Item number	Sales price
<b>① Technology cabinet / bezel plate with VC camera</b> below the LED screens VC camera cabinet dimensions: 340-540 x 215 mm (W x H)	108" - 110"	in structure lacquer arctic white	12365	2.120 Euro
		in structure lacquer lava black	12366	2.120 Euro
<b>Technology cabinet / bezel plate with VC camera,</b> outside with fabric covers for external loud speaker (each 730 x 230 mm / W x H)	108" - 110"	in structure lacquer arctic white	12369	2.420 Euro
		in structure lacquer lava black	12370	2.420 Euro
<b>Technology cabinet / bezel plate with custom cutout for VC soundbar</b> for the integration of for example Cisco Webex Room Kit (Plus) / Crestron Flex / Poly X50 / etc. incl. mounting device	108" - 110"	in structure lacquer arctic white	12371	2.420 Euro
		in structure lacquer lava black	12372	2.420 Euro
<b>Technology cabinet / bezel plate without cutout</b>	108" - 110"	in structure lacquer arctic white	12361	1.950 Euro
		in structure lacquer lava black	12362	1.950 Euro
<b>② Lateral speaker cabinets</b> for the integration of line source speakers and subwoofer (width = each 260mm)	108" - 110"	in fabric black	12373	3.450 Euro
Speaker housing: (W x D x H): - above / line source speaker cabinet: 180 x 260 x 1220 mm - below / subwoofer: 770 x 270 x 730 mm				
<b>Extended lateral speaker with VC cabinet:</b> (width = each 380 mm) Dimensions VC cabinet: 280 x 240 mm (W x H) Positioning individually adjusted (per unit / side).	108" - 110"	in fabric black	12375	5.150 Euro

# LED-Media wall\_W9 - 110 mobile (for 108" - 110" in 16 : 9 format) new

## Base module

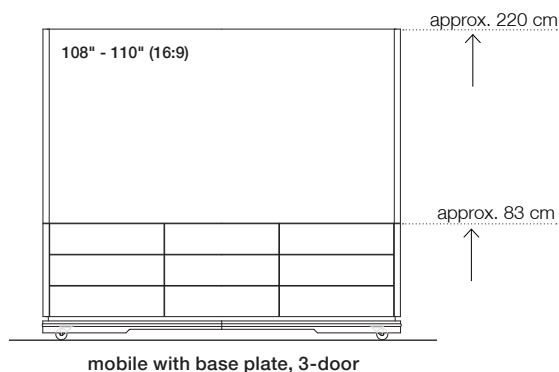

**Type / Design** Melamine housing, MDF doors, base plate and visible back side, finished with structure lacquer. With passive housing ventilation for individual technology integration. Prepared for the integration of LED screens. LED mount not included.

**approx. Dimensions (W x D x H)**

= individually adapted to LED screen

Furniture, outside (base plate)

2530 (2540) x 350 (950) x 2200 (140) mm

Technology housing (\*fittings not included)

3 x 770 x 290 x 620 mm

Mounting surface for LED screens (W x H)

2450 x 1380 mm

**Max. screen weight**

180 kg

**Color\*\* / Item number**

arctic white

12345

lava black

12346

**Base price for 1 unit**

19.980 Euro

excluding transportation

(order of 3 more = scaled conditions!)

**Shipping**





on request

Options	Surface / Color	Item number	Sales price
<b>Outer doors with speaker panels in fabric</b> for external loud speaker includes shelf space for speakers approx. 730 x 220 mm (W x H) The technology compartments reduces accordingly.	structure lacquer arctic white, fabric black	11963	890 Euro
	structure lacquer lava black, fabric black	11964	890 Euro
<b>Door lock (per door/piece)</b>	nickel-plated, matt	12036	170 Euro
<b>Shelf for technology housing</b>	structure lacquer arctic white	11966	55 Euro
	structure lacquer lava black	11967	55 Euro
<b>VC camera mount</b> for lateral positioning on LED-Media wall W9 space: 240 x 150 mm (W x D)	metal, powder coated, black	L: 11968	445 Euro
		R: 12127	445 Euro

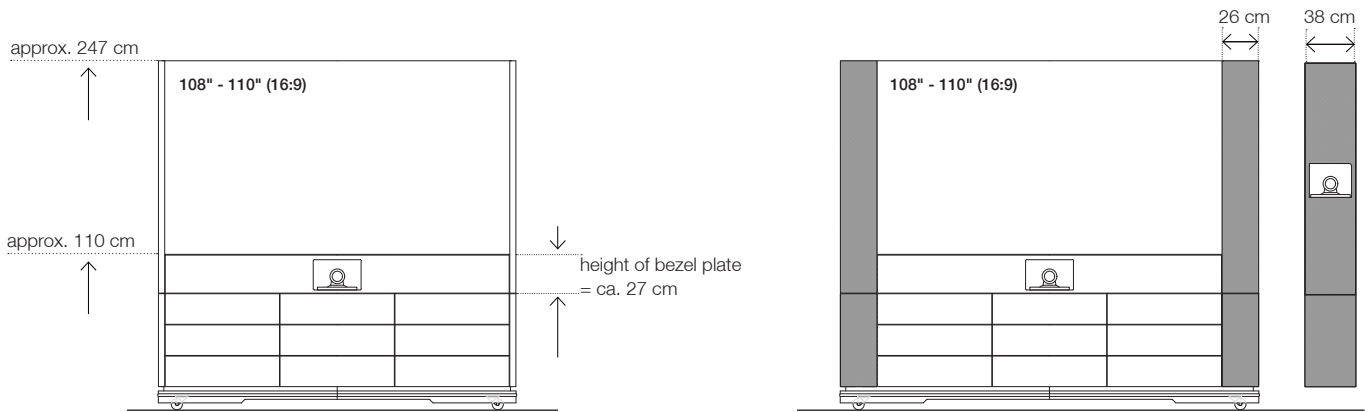
\* Structure lacquer colors can be customized on request against surcharge.  
Prices = net sales prices, excluding VAT (in Euro)

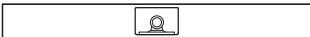
... optional ① with bezel plate for VC integration (can not be upgraded!)  
and / or ② with lateral speaker cabinets

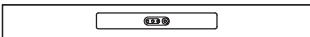

	approx. Size	Surface / Color	Item number	Sales price
<b>① Technology cabinet / bezel plate with VC camera</b> below the LED screens VC camera cabinet dimensions: 340-540 x 215 mm (W x H)		108'' - 110'' in structured varnish arctic white	12365	2.120 Euro
		in structured varnish lava black	12366	2.120 Euro
	<b>Technology cabinet / bezel plate with VC camera,</b> outside with fabric covers for external loud speaker (each 730 x 230 mm / W x H)		108'' - 110'' in structured varnish arctic white	12369
		in structured varnish lava black	12370	2.420 Euro
<b>Technology cabinet / bezel plate with custom cutout for VC soundbar</b> for the integration of for example Cisco Webex Room Kit (Plus) / Crestron Flex / Poly X50 / etc. incl. mounting device		108'' - 110'' in structured varnish arctic white	12371	2.420 Euro
		in structured varnish lava black	12372	2.420 Euro
<b>Technology cabinet / bezel plate without cutout</b>		108'' - 110'' in structured varnish arctic white	12361	1.950 Euro
		in structured varnish lava black	12362	1.950 Euro
<b>② Lateral speaker cabinets</b> for the integration of line source speakers and subwoofer (width = each 260mm) With appropriately widened base plate.		108'' - 110'' in fabric black	12381	4.470 Euro
		<b>Extended lateral speaker with VC cabinet:</b> (width = each 380 mm) Dimensions VC cabinet: 280 x 240 mm (W x H) Positioning individually adjusted (per unit / side). With appropriately widened base plate.	108'' - 110'' in fabric black	12383

## LED-Media wall\_W9 - 146 (for 136" - 146" in 16 : 9 format) new

### Base module

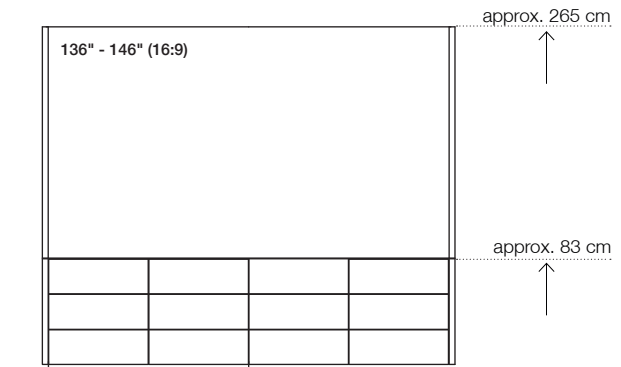

wall mounted, 4-door

#### Type / Design

Melamine housing, MDF doors and sides, finished with structure lacquer.  
With passive housing ventilation for individual technology integration.  
Prepared for the integration of LED screens.  
LED mount not included.

#### approx. Dimensions (W x D x H)

= individually adapted to LED screen

Furniture, outside

Technology housing (\*fittings not included)

Mounting surface for LED screens (W x H)

3330 x 320 x 2650 mm

4 x 720 x 270 x 730 mm

3240 x 1840 mm

#### Max. screen weight

250 kg

#### Color\*\* / Item number

arctic white

12349

lava black

12350

#### Base price for 1 unit

11.240 Euro

excluding transportation

(order of 3 more = scaled conditions!)

#### Shipping

on request

Options	Surface / Color	Item number	Sales price
<b>Outer doors with speaker panels in fabric</b> for external loud speaker includes shelf space for speakers approx. 730 x 220 mm (W x H) The technology compartments reduces accordingly.	structure lacquer arctic white, fabric black	11963	890 Euro
	structure lacquer lava black, fabric black	11964	890 Euro
<b>Door lock (per door/piece)</b>	nickel-plated, matt	12036	170 Euro
<b>Shelf for technology housing</b>	structure lacquer arctic white	11966	55 Euro
	structure lacquer lava black	11967	55 Euro
<b>VC camera mount</b> for lateral positioning on LED-Media wall W9 space: 240 x 150 mm (W x D)	metal, powder coated, black	L: 11968	445 Euro
		R: 12127	445 Euro

... optional ① with bezel plate for VC integration (can not be upgraded!)  
and / or ② with lateral speaker cabinets

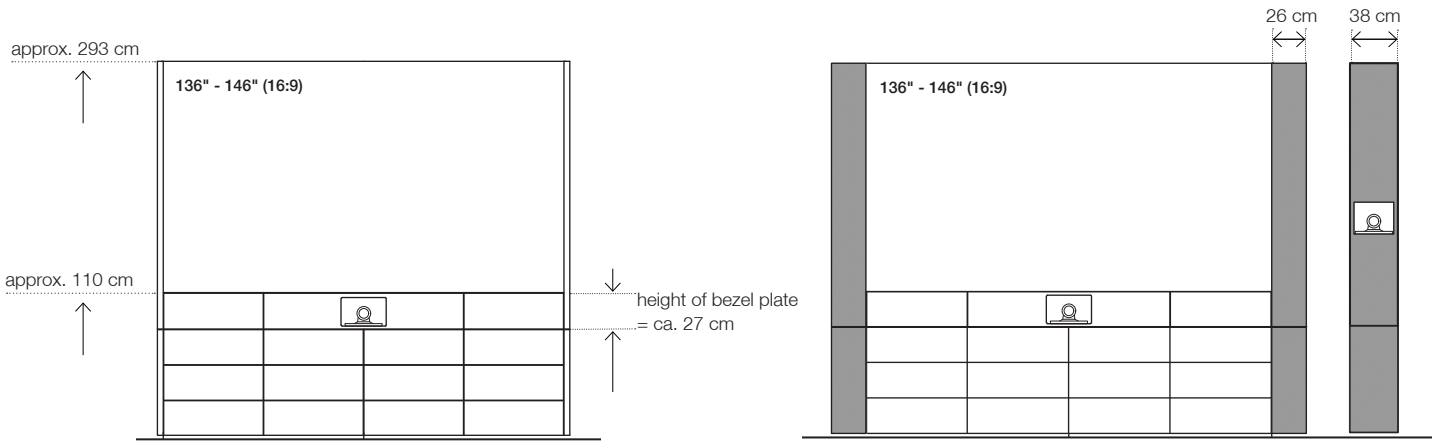

	approx. Size	Surface / Color	Item number	Sales price	
<b>① Technology cabinet / bezel plate with VC camera</b> below the LED screens VC camera cabinet dimensions: 340-540 x 215 mm (W x H)		136" - 146" in structure lacquer arctic white	12403	2.560 Euro	
		in structure lacquer lava black	12404	2.560 Euro	
	<b>Technology cabinet / bezel plate with VC camera,</b> outside with fabric covers for external loud speaker (each 720 x 230 mm / W x H)		136" - 146" in structure lacquer arctic white	12407	2.990 Euro
			in structure lacquer lava black	12408	2.990 Euro
<b>Technology cabinet / bezel plate with custom cutout for VC soundbar</b> for the integration of for example Cisco Webex Room Kit (Plus) / Crestron Flex / Poly X50 / etc. incl. mounting device		136" - 146" in structure lacquer arctic white	12409	2.990 Euro	
		in structure lacquer lava black	12410	2.990 Euro	
<b>Technology cabinet / bezel plate without cutout</b>		136" - 146" in structure lacquer arctic white	12399	2.200 Euro	
		in structure lacquer lava black	12400	2.200 Euro	
<b>② Lateral speaker cabinets</b> for the integration of line source speakers and subwoofer (width = each 260mm)		136" - 146" in fabric black	12411	3.980 Euro	
		<b>Extended lateral speaker with VC cabinet:</b> (width = each 380 mm) Dimensions VC cabinet: 280 x 240 mm (W x H) Positioning individually adjusted (per unit / side).	136" - 146" in fabric black	12413	5.480 Euro

# LED-Media wall\_W9 - 146 mobile (for 136" - 146" in 16 : 9 format) new

## Base module

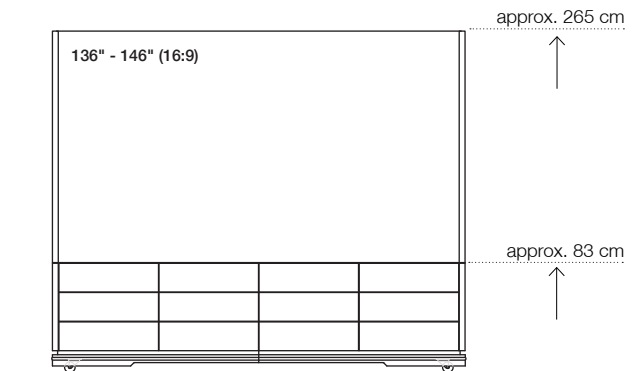





mobile with base plate, 4-door

<b>Type / Design</b>	Melamine housing, MDF doors, base plate and visible back side, finished with structure lacquer. With passive housing ventilation for individual technology integration. Prepared for the integration of LED screens. LED mount <u>not</u> included.
<b>approx. Dimensions (W x D x H)</b> = individually adapted to LED screen	
Furniture, outside (base plate)	3330 (3340) x 350 (950) x 2650 (140) mm
Technology housing (*fittings not included)	4 x 720 x 290 x 620 mm
Mounting surface for LED screens (W x H)	3240 x 1840 mm
<b>Max. screen weight</b>	250 kg
<b>Color** / Item number</b>	
arctic white	<b>12351</b>
lava black	<b>12352</b>
<b>Base price for 1 unit</b>	<b>24.320 Euro</b>
excluding transportation (order of 3 more = scaled conditions!)	
<b>Shipping</b>	<b>on request</b>

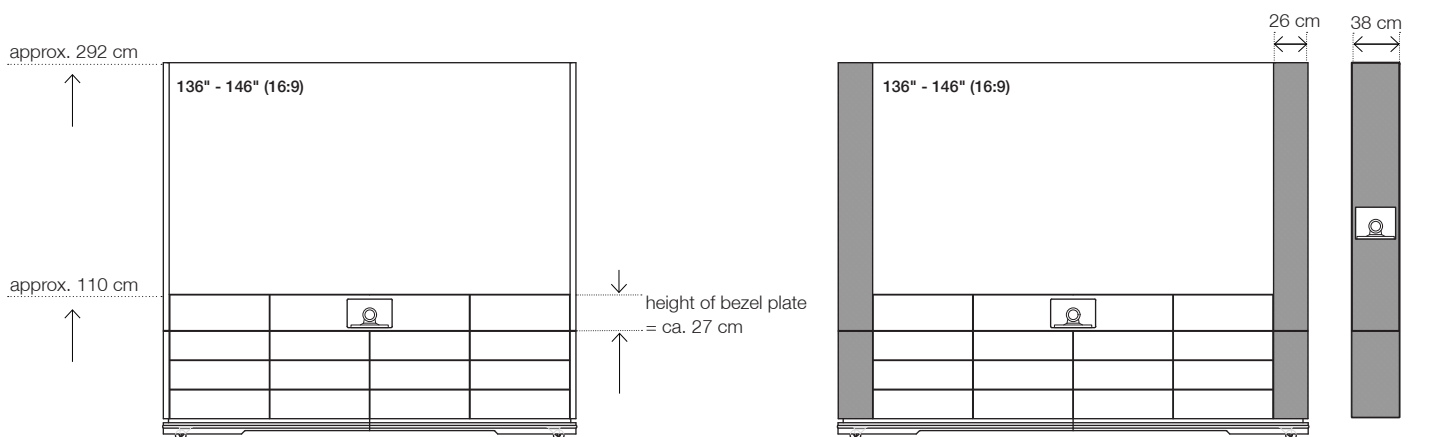
Options	Surface / Color	Item number	Sales price
<b>Outer doors with speaker panels in fabric</b> for external loud speaker includes shelf space for speakers approx. 730 x 220 mm (W x H) The technology compartments reduces accordingly.	structure lacquer arctic white, fabric black	11963	890 Euro
	structure lacquer lava black, fabric black	11964	890 Euro
<b>Door lock (per door/piece)</b>	nickel-plated, matt	12036	170 Euro
<b>Shelf for technology housing</b>	structure lacquer arctic white	11966	55 Euro
	structure lacquer lava black	11967	55 Euro
<b>VC camera mount</b> for lateral positioning on LED-Media wall W9 space: 240 x 150 mm (W x D)	metal, powder coated, black	L: 11968	445 Euro
		R: 12127	445 Euro

... optional ① with bezel plate for VC integration (can not be upgraded!)  
and / or ② with lateral speaker cabinets



	approx. Size	Surface / Color	Item number	Sales price
<b>① Technology cabinet / bezel plate with VC camera</b> below the LED screens VC camera cabinet dimensions: 340-540 x 215 mm (W x H)				
	136" - 146"	in structure lacquer arctic white in structure lacquer lava black	12403	2.560 Euro
			12404	2.560 Euro
<b>Technology cabinet / bezel plate with VC camera,</b> outside with fabric covers for external loud speaker (each 720 x 230 mm / W x H)				
	136" - 146"	in structure lacquer arctic white in structure lacquer lava black	12407	2.990 Euro
			12408	2.990 Euro
<b>Technology cabinet / bezel plate with custom cutout for VC soundbar</b> for the integration of for example Cisco Webex Room Kit (Plus) / Crestron Flex / Poly X50 / etc. incl. mounting device				
	136" - 146"	in structure lacquer arctic white in structure lacquer lava black	12409	2.990 Euro
			12410	2.990 Euro
<b>Technology cabinet / bezel plate without cutout</b>				
	136" - 146"	in structure lacquer arctic white in structure lacquer lava black	12399	2.200 Euro
			12400	2.200 Euro
<b>② Lateral speaker cabinets</b> for the integration of line source speakers and subwoofer (width = each 260mm) With appropriately widened base plate.				
Speaker housing: (W x D x H): - above / line source speaker cabinet: 180 x 260 x 1680 mm - below / subwoofer: 720 x 290 x 620 mm				
	136" - 146"	in fabric black	12419	4.890 Euro
<b>Extended lateral speaker with VC cabinet:</b> (width = each 380 mm) Dimensions VC cabinet: 280 x 240 mm (W x H) Positioning individually adjusted (per unit / side). With appropriately widened base plate.				
	136" - 146"	in fabric black	12421	6.320 Euro

# LED-Media wall\_W9 - 165 (for 162" - 165" in 16 : 9 format)

## Base module

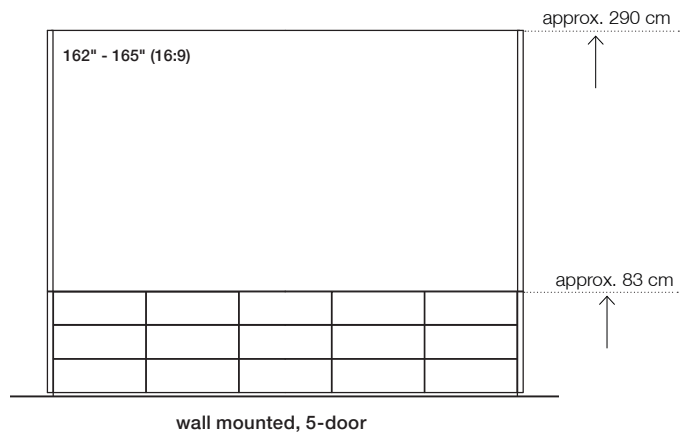

### Type / Design

Melamine housing, MDF doors and sides, finished with structure lacquer.  
 With passive housing ventilation for individual technology integration.  
 Prepared for the integration of LED screens.  
 LED mount not included.

### approx. Dimensions (W x D x H)

= individually adapted to LED screen

Furniture, outside	3750 x 320 x 2890 mm
Technology housing (*fittings not included)	5 x 690 x 270 x 730 mm
Mounting surface for LED screens (W x H)	3660 x 2060 mm

### Max. screen weight

350 kg

### Color\*\* / Item number

arctic white	12355
lava black	12356

### Base price for 1 unit

13.790 Euro

excluding transportation  
 (order of 3 more = scaled conditions!)

### Shipping

on request





Options	Surface / Color	Item number	Sales price
<b>Outer doors with speaker panels in fabric</b> for external loud speaker includes shelf space for speakers approx. 730 x 220 mm (W x H) The technology compartments reduces accordingly.	structure lacquer arctic white, fabric black	11963	890 Euro
	structure lacquer lava black, fabric black	11964	890 Euro
<b>Door lock (per door/piece)</b>	nickel-plated, matt	12036	170 Euro
<b>Shelf for technology housing</b>	structure lacquer arctic white	11966	55 Euro
	structure lacquer lava black	11967	55 Euro
<b>VC camera mount</b> for lateral positioning on LED-Media wall W9 space: 240 x 150 mm (W x D)	metal, powder coated, black	L: 11968	445 Euro
		R: 12127	445 Euro

\* Structure lacquer colors can be customized on request against surcharge.  
 Prices = net sales prices, excluding VAT (in Euro)

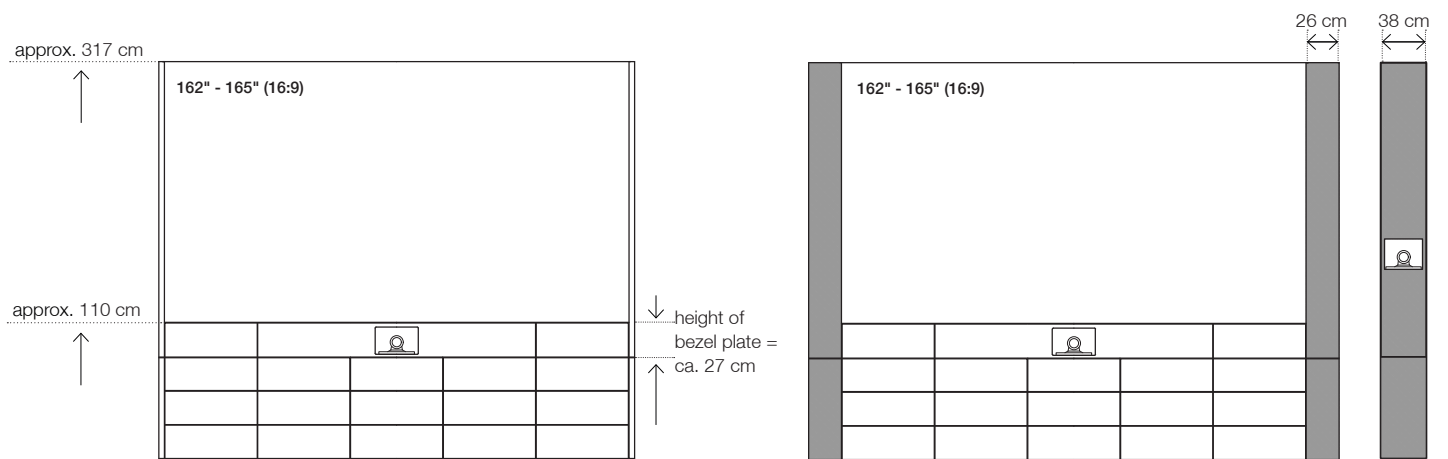

... optional ① with bezel plate for VC integration (can not be upgraded!)  
and / or ② with lateral speaker cabinets



	approx. Size	Surface / Color	Item number	Sales price	
<b>① Technology cabinet / bezel plate with VC camera</b> below the LED screens VC camera cabinet dimensions: 340-540 x 215 mm (W x H)		162" - 165" in structure lacquer arctic white	12443	3.070 Euro	
		in structure lacquer lava black	12444	3.070 Euro	
	<b>Technology cabinet / bezel plate with VC camera,</b> outside with fabric covers for external loud speaker (each 690 x 230 mm / W x H)		162" - 165" in structure lacquer arctic white	12447	3.450 Euro
			in structure lacquer lava black	12448	3.450 Euro
	<b>Technology cabinet / bezel plate with custom cutout for VC soundbar</b> for the integration of for example Cisco Webex Room Kit (Plus) / Crestron Flex / Poly X50 / etc. incl. mounting device		162" - 165" in structure lacquer arctic white	12449	3.450 Euro
			in structure lacquer lava black	12450	3.450 Euro
	<b>Technology cabinet / bezel plate without cutout</b>		162" - 165" in structure lacquer arctic white	12439	2.790 Euro
			in structure lacquer lava black	12440	2.790 Euro
	<b>② Lateral speaker cabinets</b> for the integration of line source speakers and subwoofer (width = each 260mm)	162" - 165"	in fabric black	12451	4.440 Euro
			Speaker housing: (W x D x H): - above / line source speaker cabinet: 180 x 260 x 1990 mm - below / subwoofer: 690 x 270 x 730 mm		
<b>Extended lateral speaker with VC cabinet:</b> (width = each 380 mm) Dimensions VC cabinet: 280 x 240 mm (W x H) Positioning individually adjusted (per unit / side).	162" - 165"	in fabric black	12453	5.980 Euro	

## LED-Media wall\_W9 - 165 mobil (for 162" - 165" in 16 : 9 format) new

### Base module

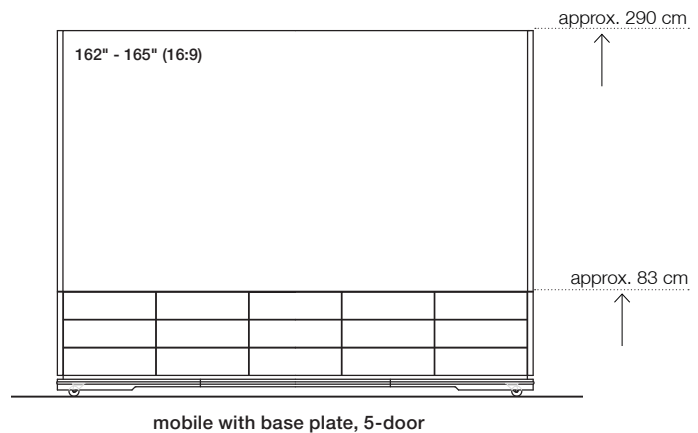

#### Type / Design

Melamine housing, MDF doors, base plate and visible back side, finished with structure lacquer.  
With passive housing ventilation for individual technology integration.  
Prepared for the integration of LED screens.  
LED mount not included.

#### approx. Dimensions (W x D x H)

= individually adapted to LED screen

Furniture, outside (base plate)

3750 (3760) x 350 (950) x 2890 (140) mm

Technology housing (\*fittings not included)

5 x 690 x 290 x 620 mm

Mounting surface for LED screens (W x H)

3660 x 2060 mm

#### Max. screen weight

350 kg

#### Color\*\* / Item number

arctic white

12357

lava black

12358

#### Base price for 1 unit

32.250 Euro

excluding transportation

(order of 3 more = scaled conditions!)





#### Shipping

on request

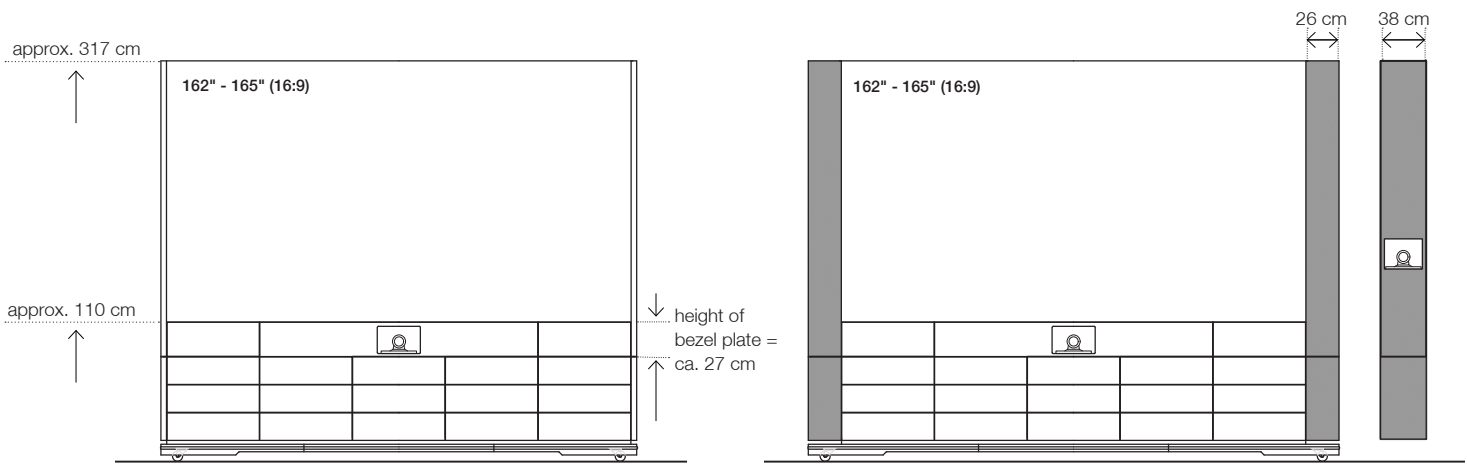
Options	Surface / Color	Item number	Sales price
<b>Outer doors with speaker panels in fabric</b> for external loud speaker includes shelf space for speakers approx. 730 x 220 mm (W x H) The technology compartments reduces accordingly.	structure lacquer arctic white, fabric black	11963	890 Euro
	structure lacquer lava black, fabric black	11964	890 Euro
<b>Door lock (per door/piece)</b>	nickel-plated, matt	12036	170 Euro
<b>Shelf for technology housing</b>	structure lacquer arctic white	11966	55 Euro
	structure lacquer lava black	11967	55 Euro
<b>VC camera mount</b> for lateral positioning on LED-Media wall W9 space: 240 x 150 mm (W x D)	metal, powder coated, black	L: 11968	445 Euro
		R: 12127	445 Euro

... optional ① with bezel plate for VC integration (can not be upgraded!)  
and / or ② with lateral speaker cabinets



	approx. Size	Surface / Color	Item number	Sales price	
<p><b>① Technology cabinet / bezel plate with VC camera</b> below the LED screens VC camera cabinet dimensions: 340-540 x 215 mm (W x H)</p>  <p><b>Technology cabinet / bezel plate with VC camera,</b> outside with fabric covers for external loud speaker (each 690 x 230 mm / W x H)</p>  <p><b>Technology cabinet / bezel plate with custom cutout for VC soundbar</b> for the integration of for example Cisco Webex Room Kit (Plus) / Crestron Flex / Poly X50 / etc. incl. mounting device</p>  <p><b>Technology cabinet / bezel plate without cutout</b></p> 	162" - 165"	in structure lacquer arctic white in structure lacquer lava black	12443 12444	3.070 Euro 3.070 Euro	
	162" - 165"	in structure lacquer arctic white in structure lacquer lava black	12447 12448	3.450 Euro 3.450 Euro	
	162" - 165"	in structure lacquer arctic white in structure lacquer lava black	12449 12450	3.450 Euro 3.450 Euro	
	162" - 165"	in structure lacquer arctic white in structure lacquer lava black	12439 12440	2.790 Euro 2.790 Euro	
	<p><b>② Lateral speaker cabinets</b> for the integration of line source speakers and subwoofer (width = each 260mm) With appropriately widened base plate.</p> <p>Speaker housing: (W x D x H): - above / line source speaker cabinet: 180 x 260 x 1990 mm - below / subwoofer: 690 x 290 x 620 mm</p> <p><b>Extended lateral speaker with VC cabinet:</b> (width = each 380 mm) Dimensions VC cabinet: 280 x 240 mm (W x H) Positioning individually adjusted (per unit / side). With appropriately widened base plate.</p>	162" - 165"	in fabric black	12459	5.430 Euro
		162" - 165"	in fabric black	12461	7.110 Euro

## LED-Media wall\_W9 - 110<sup>2</sup> (for 2 x 108" - 110" in 16 : 9 format) new

### Base module

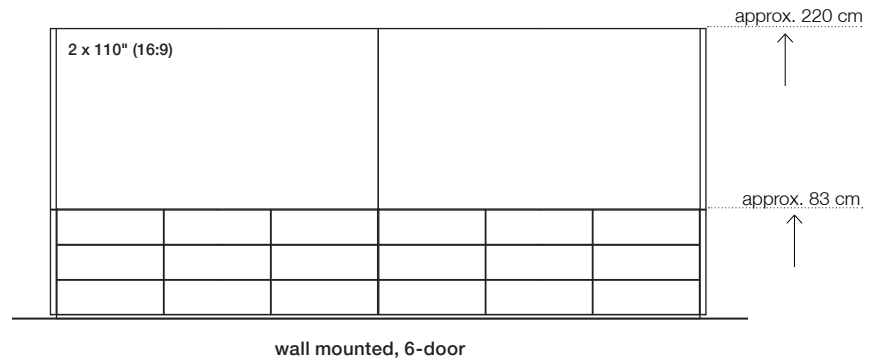

### Type / Design

Melamine housing, MDF doors and sides, finished with structure lacquer.  
With passive housing ventilation for individual technology integration.  
Prepared for the integration of LED screens.  
LED mount not included.

### approx. Dimensions (W x D x H)

= individually adapted to LED screen

Furniture, outside

4980 x 320 x 2200 mm

Technology housing (\*fittings not included)

6 x 770 x 270 x 730 mm

Mounting surface for LED screens (W x H)

4900 x 1380 mm

### Max. screen weight

360 kg

### Color\*\* / Item number

arctic white

12477

lava black

12478

### Base price for 1 unit

15.850 Euro

excluding transportation

(order of 3 more = scaled conditions!)



### Shipping

on request

Options	Surface / Color	Item number	Sales price
<b>Outer doors with speaker panels in fabric</b> for external loud speaker includes shelf space for speakers approx. 730 x 220 mm (W x H) The technology compartments reduces accordingly.	structure lacquer arctic white, fabric black	11963	890 Euro
	structure lacquer lava black, fabric black	11964	890 Euro
<b>Door lock (per door/piece)</b>	nickel-plated, matt	12036	170 Euro
<b>Shelf for technology housing</b>	structure lacquer arctic white	11966	55 Euro
	structure lacquer lava black	11967	55 Euro
<b>VC camera mount</b> for lateral positioning on LED-Media wall W9 space: 240 x 150 mm (W x D)	metal, powder coated, black	L: 11968	445 Euro
		R: 12127	445 Euro

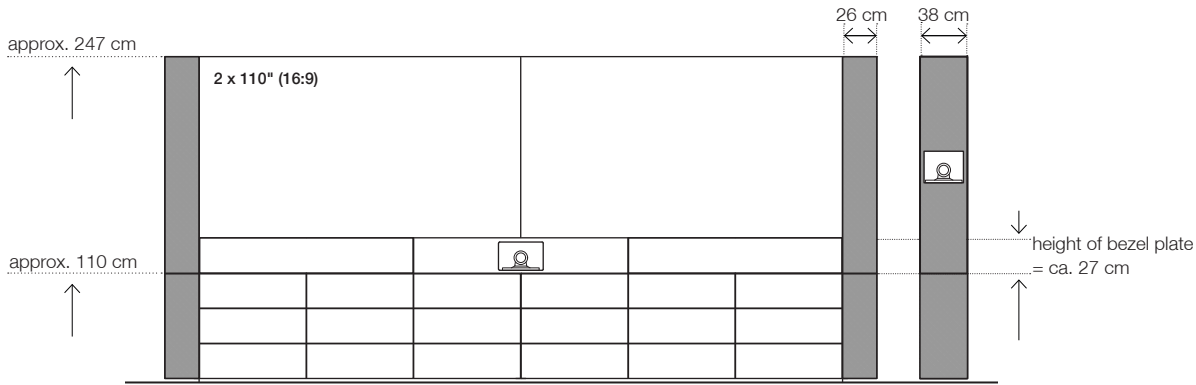
... optional ① with bezel plate for VC integration (can not be upgraded!)  
and / or ② with lateral speaker cabinets

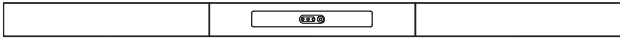
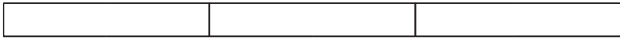

	approx. Size	Surface / Color	Item number	Sales price
<b>① Technology cabinet / bezel plate with VC camera</b> below the LED screens VC camera cabinet dimensions: 340-540 x 215 mm (W x H)	2 x 110"	in structure lacquer arctic white	12483	3.950 Euro
		in structure lacquer lava black	12484	3.950 Euro
<b>Technology cabinet / bezel plate with VC camera,</b> outside with fabric covers for external loud speaker (each 1600 x 230 mm / W x H)	2 x 110"	in structure lacquer arctic white	12487	4.330 Euro
		in structure lacquer lava black	12488	4.330 Euro
<b>Technology cabinet / bezel plate with custom cutout</b> <b>for VC soundbar</b> for the integration of for example Cisco Webex Room Kit (Plus) / Crestron Flex / Poly X50 / etc. incl. mounting device	2 x 110"	in structure lacquer arctic white	12489	4.330 Euro
		in structure lacquer lava black	12490	4.330 Euro
<b>Technology cabinet / bezel plate without cutout</b>	2 x 110"	in structure lacquer arctic white	12479	3.510 Euro
		in structure lacquer lava black	12480	3.510 Euro
<b>② Lateral speaker cabinets</b> for the integration of line source speakers and subwoofer (width = each 260mm)	2 x 110"	in fabric black	12491	3.450 Euro
Speaker housing: (W x D x H): - above / line source speaker cabinet: 180 x 260 x 1220 mm - below / subwoofer: 770 x 270 x 730 mm				
<b>Extended lateral speaker with VC cabinet:</b> (width = each 380 mm) Dimensions VC cabinet: 280 x 240 mm (W x H) Positioning individually adjusted (per unit / side).	2 x 110"	in fabric black	12493	5.150 Euro

## General Elements options

(not available for W6 due to serial production!)

Options	Surface / Color		Item number	Sales price
<b>Custom structure lacquer colors</b> according to specification in RAL or NCS color system		single per order	INDIV_SL	590 Euro
<b>Custom cutouts</b> for free positioning of keypads, control panels or connector panels		inside unlacquered inside lacquered	11945 11946	130 Euro 190 Euro
<b>Sleeve for cable routing Ø 20 mm</b> custom positioning, includes cutout and installation	stainless steel		10205	150 Euro
<b>Grommet Ø 60 mm</b> for free positioning, incl. cutouts in housing	plastic	white black	10574 10719	140 Euro 140 Euro
<b>custom furniture adjustment</b>				10% surcharge on the base item
<b>Profile cylinder lock with rosette for customer-side profile cylinder</b>				170 Euro
<b>19-inch rack – 4HU</b> for vertical mounting of 19-inch devices in a media column. Easy cable routing and maintenance through integrated mounting and swivel mechanism 520 x 205 x 195 mm (W x H x D) <u>Attention:</u> For space reasons the use of the rack is not possible in the W8 M and L - as well as in all S1. In the W8 L <sup>2</sup> and W8 XXL the rack fits only in the center cabinet.	metal, powder coated, black	black	10442	330 Euro
<b>Delivery, set up and instruction by Holzmedia</b>				on request

## Replacement bezel plates for Media column\_W8

Replacement bezel plates	Surface / Color*	Sales price
<b>Speaker cover standard</b> spare part as in the main product	acoustic fabric black, back with structure lacquer	
Size M		390 Euro
Size L		490 Euro
Size XL		590 Euro
Size XXL		690 Euro
Size M <sup>2</sup>		590 Euro
Size L <sup>2</sup>		690 Euro
Size XL <sup>2</sup>		790 Euro
<b>Custom speaker cover</b> with custom cutout	acoustic fabric black, back lacquered in structure lacquer arctic white or lava black	
Size M		590 Euro
Size L		690 Euro
Size XL		790 Euro
Size XXL		890 Euro
Size M <sup>2</sup>		790 Euro
Size L <sup>2</sup>		890 Euro
Size XL <sup>2</sup>		990 Euro
<b>Custom VC bezel plate</b> with cutout and mounting device for VC soundbar	made of MDF in structure lacquer arctic white or lava black	
Size M		590 Euro
Size L		690 Euro
Size XL		790 Euro
Size XXL		890 Euro
Size M <sup>2</sup>		790 Euro
Size L <sup>2</sup>		890 Euro
Size XL <sup>2</sup>		990 Euro
<b>VC camera housing below display</b> with centrally divided speaker cover	structure lacquer arctic white or lava black acoustic fabric black	
Size L		690 Euro
Size XL		790 Euro
Size XXL		890 Euro
Size M <sup>2</sup>		790 Euro
Size L <sup>2</sup>		890 Euro
Size XL <sup>2</sup>		990 Euro

# Additions

Supplementary furniture that rounds off our performance profile



## Lectern\_X3

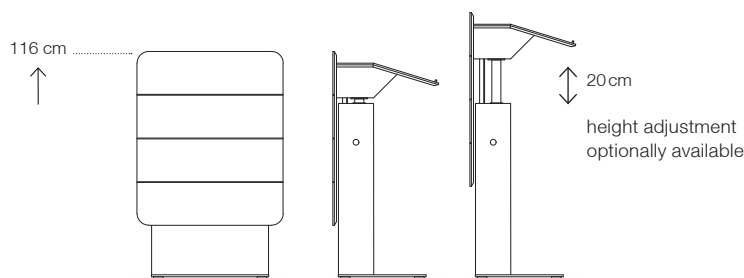

detached

## Type / Design

Front cover, housing and doors made of MDF, finished with structure lacquer.  
With storage space for individual technology integration. Floor plate made of metal, powder coated.  
Incl. lowering for water glass, tablet holder and laterally extensible stainless steel handles for carrying the lectern.

## Type / Design storage surface:

## Dimensions (W x D x H)

Furniture, outside	750 x 545/180 x 1160 mm
Technology housing (*fittings not included)	560 x 140 x 780 mm
Storage surface (W x D)	670 x 350 mm

## Color\* / Item number

arctic white	12019
lava black	12020

## Base price for 1 unit

excluding transportation	6.340 Euro
(order of 3 or more = scaled conditions!)	on request

## Shipping

on request

Options	Surface / Color	Item number	Sales price
<b>Electrical height adjustment about 20 cm</b> reduced technology storage space = 560 x 140 x 200 mm + 200 x 140 x 550 mm (W x D x H)		10433	1.550 Euro
<b>Preparation for additional microphone</b> sound-insulated mount	black	12021	190 Euro
<b>Custom cutout for connector panel</b>	inside unlacquered	12040	130 Euro
	inside lacquered	12041	190 Euro
<b>Cutout for "Power Frame Cover Small" connector panel (3-fold)</b>	inside unlacquered	12026	130 Euro
<b>Installation frame with cover flap for "Power Frame Cover Small" (3-fold)</b> without socket unit	white	10502	540 Euro
	black	10503	540 Euro
<b>Reading light</b> top left in lectern integrated	anodized aluminum	10435	540 Euro
	black anodized aluminum	10753	540 Euro
<b>Door lock</b>	nickel-plated, matt	10436	170 Euro
<b>Lower shelf for technology housing</b> only without height adjustment applicable!	structure lacquer arctic white	10437	50 Euro
	structure lacquer lava black	10752	50 Euro
<b>Logopanel</b> magnetic, 750 x 10 x 220 mm (W x D x H)	structure lacquer arctic white	10236	790 Euro
	structure lacquer lava black	10774	790 Euro
<b>Trolley</b> 790 x 620 x 140 mm (W x D x H)	made of MDF, black	10871	490 Euro

## Media Cube\_X4 - regular

as a mobile media unit at table height

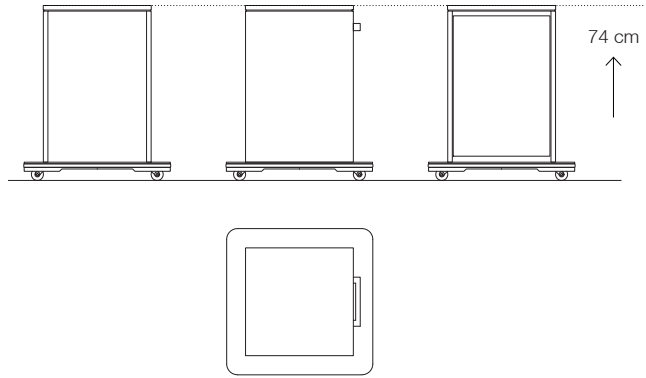

### Type / Design

Housing and base plate made of MDF, finished with structure lacquer.  
With various options for the integration of technology  
as well as data connector panels.

### Type / Design storage surface:

### Dimensions (W x D x H)

- Furniture, outside (base plate)	450/610 x 450/610 x 740 mm
- Technology housing (fittings not included)	410 x 410 x 640 mm
- Storage surface (W x D)	450 x 450 mm

### Color\* / Item number

arctic white	11324
lava black	11325

### Base price for 1 unit

excluding transportation	1.660 Euro
(order of 3 or more = scaled conditions!)	on request

### Shipping

on request

Options	Surface / Color	Item number	Sales price	
<b>Cable roll holder</b> on the back side of the mobile version	structure lacquer arctic white	11345	160 Euro	
	structure lacquer lava black	11346	160 Euro	
<b>Custom cutouts</b> for free positioning of keypads, control panels or connector panels	inside unlacquered	12040	130 Euro	
	inside lacquered	12041	190 Euro	
<b>Sleeve for cable routing Ø 20 mm</b> custom positioning, includes cutout and installation	stainless steel	12042	150 Euro	
<b>Grommet Ø 60 mm</b> for free positioning, incl. cutouts in body	plastic	white	12043	140 Euro
		black	12044	140 Euro
<b>Door lock (per door/piece)</b>	nickel-plated, matt	11334	170 Euro	
<b>Shelf for technology housing</b>	structure lacquer arctic white	11878	55 Euro	
	structure lacquer lava black	11879	55 Euro	
<b>Data connector panel / media flap</b>			on request	

# Media Cube\_X4 - high

as a mobile media unit at standing table height

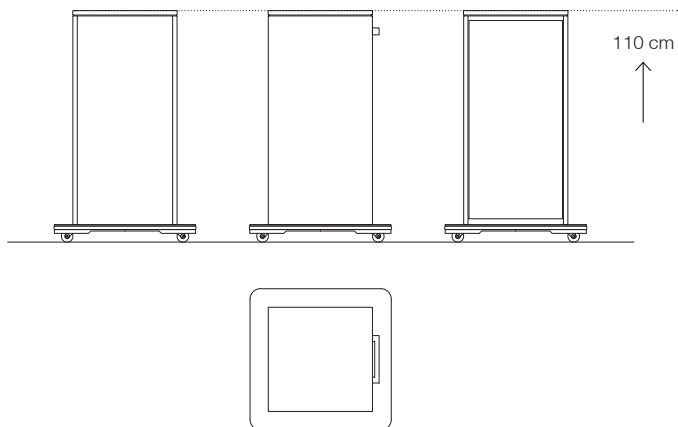

**Type / Design** Housing and base plate made of MDF, finished with structure lacquer. With various options for the integration of technology as well as data connector panels.

**Type / Design storage surface:**

**Dimensions (W x D x H)**

- Furniture, outside (base plate)	450/610 x 450/610 x 1100 mm
- Technology housing (fittings not included)	410 x 410 x 1000 mm
- Storage surface (W x D)	450 x 450 mm

**Color\* / Item number**

arctic white	<b>11326</b>
lava black	<b>11327</b>

**Base price for 1 unit**

excluding transportation	<b>1.880 Euro</b>
(order of 3 or more = scaled conditions!)	on request

**Shipping** on request

Options	Surface / Color	Item number	Sales price
<b>Cable roll holder</b> on the back side of the mobile version	structure lacquer arctic white	11345	160 Euro
	structure lacquer lava black	11346	160 Euro
<b>Custom cutouts</b> for free positioning of keypads, control panels or connector panels	inside unlacquered	12040	130 Euro
	inside lacquered	12041	190 Euro
<b>Sleeve for cable routing Ø 20 mm</b> custom positioning, includes cutout and installation	stainless steel	12042	150 Euro
<b>Grommet Ø 60 mm</b> for free positioning, incl. cutouts in body	plastic white	12043	140 Euro
	plastic black	12044	140 Euro
<b>Door lock (per door/piece)</b>	nickel-plated, matt	11334	170 Euro
<b>Shelf for technology housing</b>	structure lacquer arctic white	11878	55 Euro
	structure lacquer lava black	11879	55 Euro
<b>Data connector panel / media flap</b>			on request

\* Structure lacquer colors can be customized on request against surcharge.  
Prices = net sales prices, excluding VAT (in Euro)

## Display Caddy\_X5 new

for 50" to 65" displays  
with up to 60 kg weight

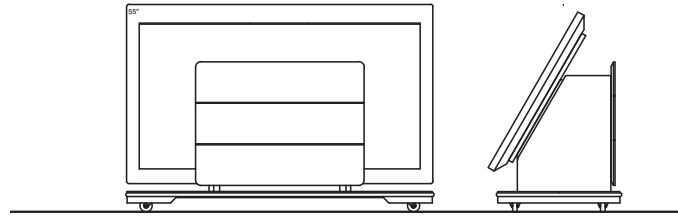

mobile

### Type / Design

#### Dimensions (W x D x H)

Furniture, outside (base plate)

690 (1250) x 400 (500) x 800 (85) mm

Technology housing (\*fitting not included)

440 x 180/350 x 450 mm

#### Requirements for display integration

- max. display width

1600 mm

- max. display weight

60 kg

- space for display / mount (W x H)

1150 x 600 mm

#### Color\* / Item number

arctic white

12525

lava black

12526

#### Base price for 1 unit

excluding transportation

3.960 Euro

(order of 3 or more = scaled conditions!)

on request

#### Shipping

on request

Options	Surface / Color	Item number	Sales price
<b>VC camera mount</b> for position in front of speaker cover, space 240 x 165 mm (W x D)	metal, powder coated, black	10033	220 Euro
<b>Door lock (per door/piece)</b>	nickel-plated, matt	12524	170 Euro

\* Structure lacquer colors can be customized on request against surcharge.

Prices = net sales prices, excluding VAT (in Euro)



**Holzmedia  
Tables**

# **Table systems** for conference and meetings rooms

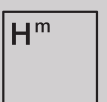

Holzmedia

# Conference table\_C12

cutouts and data connection panels not included



C12-240 for 8 people	Type / Design Dimension in cm	Color / Surface	Item number	Sales price	
	Rectangular shape with rounded edges 240 x 120 x 74 (W x D x H)	<b>Melamine white, chipboard</b> Straight edge, for data connection panel with frame	R: 10114 B: 10115	<b>2.960 Euro</b>	
		Rounded boat shape 240 x 110/120 x 74 (W x D x H)	<b>White, table top in MDF</b> data connection panel frameless possible	R: 10116 B: 10117	<b>4.865 Euro</b>
			<b>Oak, table top in MDF</b> data connection panel frameless possible	R: 10118 B: 10119	<b>4.865 Euro</b>
	Table top 25 mm thick, chamfered edge, table top 1-piece, substructure with 4 legs.	<b>WhitePlex*</b> Straight edge, for data connection panel with frame	R: 10122 B: 10123	<b>8.240 Euro</b>	
		<b>Shipping</b>		<b>on request</b>	

C12-320 for 10 people	Type / Design Dimension in cm	Color / Surface	Item number	Sales price	
	Rectangular shape with rounded edges 320 x 120 x 74 (W x D x H)	<b>Melamine white, chipboard</b> Straight edge, for data connection panel with frame	R: 10124 B: 10125	<b>3.760 Euro</b>	
		Rounded boat shape 320 x 110/120 x 74 (W x D x H)	<b>White, table top in MDF</b> data connection panel frameless possible	R: 10126 B: 10127	<b>5.640 Euro</b>
			<b>Oak, table top in MDF</b> data connection panel frameless possible	R: 10128 B: 10129	<b>5.640 Euro</b>
	Table top 25 mm thick, chamfered edge, table top 2-pieces, substructure with 4 (at WhitePlex=6) legs.	<b>WhitePlex*</b> Straight edge, for data connection panel with frame	R: 10132 B: 10133	<b>10.240 Euro</b>	
		<b>Shipping</b>		<b>on request</b>	

C12-480 for 14 people	Type / Design Dimension in cm	Color / Surface	Item number	Sales price	
	Rectangular shape with rounded edges 480 x 140 x 74 (W x D x H)	<b>Melamine white, chipboard</b> Straight edge, for data connection panel with frame	R: 10134 B: 10135	<b>5.565 Euro</b>	
		Rounded boat shape 480 x 130/140 x 74 (W x D x H)	<b>White, table top in MDF</b> data connection panel frameless possible	R: 10136 B: 10137	<b>9.085 Euro</b>
			<b>Oak, table top in MDF</b> data connection panel frameless possible	R: 10138 B: 10139	<b>9.085 Euro</b>
	Table top 25 mm thick, chamfered edge, table top 2-pieces, substructure with 6 legs.	<b>WhitePlex*</b> Straight edge, for data connection panel with frame	R: 10142 B: 10143	<b>16.145 Euro</b>	
		<b>Shipping</b>		<b>on request</b>	

Prices = net sales prices, excluding VAT (in Euro)

\* for WhitePlex we recommend: delivery and installation by Holzmedia – invoicing according to actual expenses

## Conference table\_C12

cutouts and data connection panels not included

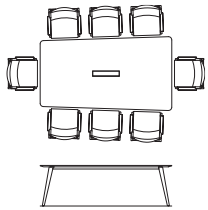
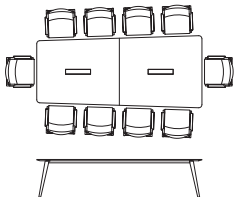
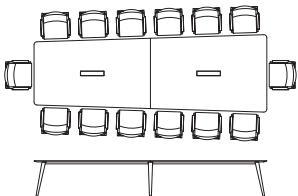
C12-240 for 6 - 8 people	Type / Design Dimension in cm	Color / Surface	Item number	Sales price
	Trapezium shape 240 x 135/120 x 74 (W x D x H)	<b>Melamine white, chipboard</b> Straight edge, for data connection panel with frame	10144	<b>3.490 Euro</b>
		<b>White, table top in MDF</b> data connection panel frameless possible	10145	<b>5.070 Euro</b>
		<b>Oak, table top in MDF</b> data connection panel frameless possible	10146	<b>5.070 Euro</b>
	Table top 25 mm thick, chamfered edge, Table top 1-piece, substructure with 4 legs.	<b>WhitePlex*</b> Straight edge, for data connection panel with frame	10148	<b>8.715 Euro</b>
		<b>Shipping</b>		<b>on request</b>
C12-320 for 8 - 10 people	Type / Design Dimension in cm	Color / Surface	Item number	Sales price
	Trapezium shape 320 x 140/120 x 74 (W x D x H)	<b>Melamine white, chipboard</b> Straight edge, for data connection panel with frame	10149	<b>4.395 Euro</b>
		<b>White, table top in MDF</b> data connection panel frameless possible	10150	<b>6.870 Euro</b>
		<b>Oak, table top in MDF</b> data connection panel frameless possible	10151	<b>6.870 Euro</b>
	Table top 25 mm thick, chamfered edge, table top 2-pieces, substructure with 4 (at WhitePlex=6) legs.	<b>WhitePlex*</b> Straight edge, for data connection panel with frame	10153	<b>10.590 Euro</b>
		<b>Shipping</b>		<b>on request</b>
C12-480 for 12 - 14 people	Type / Design Dimension in cm	Color / Surface	Item number	Sales price
	Trapezium shape 480 x 160/130 x 74 (W x D x H)	<b>Melamine white, chipboard</b> Straight edge, for data connection panel with frame	10154	<b>6.240 Euro</b>
		<b>White, table top in MDF</b> data connection panel frameless possible	10155	<b>10.090 Euro</b>
		<b>Oak, table top in MDF</b> data connection panel frameless possible	10156	<b>10.090 Euro</b>
	Table top 25 mm thick, chamfered edge, table top 2-pieces, substructure with 6 legs.	<b>WhitePlex*</b> Straight edge, for data connection panel with frame	10158	<b>16.610 Euro</b>
		<b>Shipping</b>		<b>on request</b>

Prices = net sales prices, excluding VAT (in Euro)

\* for WhitePlex we recommend: delivery and installation by Holzmedia – invoicing according to actual expenses

Holzmedia GmbH

## Conference table\_C12

cutouts and data connection panels not included

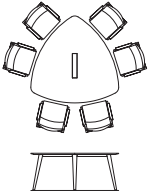
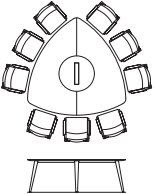
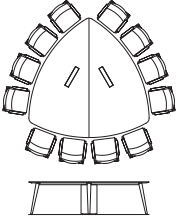
C12-173 for 6 people	Type / Design Dimension in cm	Color / Surface	Item number	Sales price
	Triangular shape 173 x 74 (L x H)	<b>Melamine white, chipboard</b> Straight edge, for data connection panel with frame	10159	3.160 Euro
		<b>White, table top in MDF</b> data connection panel frameless possible	10160	4.830 Euro
		<b>Oak, table top in MDF</b> data connection panel frameless possible	10161	4.830 Euro
		<b>WhitePlex*</b> Straight edge, for data connection panel with frame	10163	8.385 Euro
<b>Shipping</b>				on request
C12-220 for 9 people	Type / Design Dimension in cm	Color / Surface	Item number	Sales price
	Triangular shape 220 x 74 (L x H)	<b>Melamine white, chipboard</b> Straight edge, for data connection panel with frame	10164	4.570 Euro
		<b>White, table top in MDF</b> data connection panel frameless possible	10165	6.840 Euro
		<b>Oak, table top in MDF</b> data connection panel frameless possible	10166	6.840 Euro
		<b>WhitePlex*</b> Straight edge, for data connection panel with frame	10168	10.195 Euro
<b>Shipping</b>				on request
C12-270 für 12 people	Type / Design Dimension in cm	Color / Surface	Item number	Sales price
	Triangular shape 270 x 74 (L x H)	<b>Melamine white, chipboard</b> Straight edge, for data connection panel with frame	10169	6.275 Euro
		<b>White, table top in MDF</b> data connection panel frameless possible	10170	9.995 Euro
		<b>Oak, table top in MDF</b> data connection panel frameless possible	10171	9.995 Euro
		<b>WhitePlex*</b> Straight edge, for data connection panel with frame	10173	16.470 Euro
<b>Shipping</b>				on request



## Conference table\_C12

cutouts and data connection panels not included

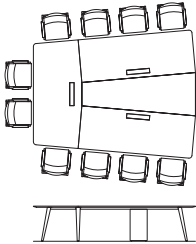
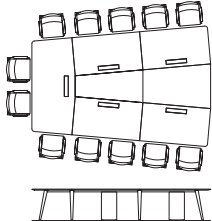
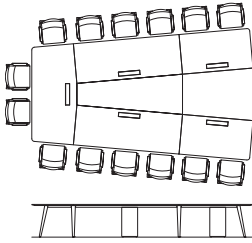
C12-340 for 10 people	Type / Design Dimension in cm	Color / Surface	Item number	Sales price
	<b>V-shape</b> with middle insert closed 341 x 212/270 x 74 (W x D x H)	<b>Melamine white, chipboard</b> Straight edge, for data connection panel with frame	10174	9.930 Euro
		<b>White, table top in MDF</b> data connection panel frameless possible	10175	13.845 Euro
		<b>Oak, table top in MDF</b> data connection panel frameless possible	10176	13.845 Euro
		<b>WhitePlex*</b> Straight edge, for data connection panel with frame	10178	19.195 Euro
	Table top 90 cm deep, 25 mm thick, chamfered edge, table top 3-pieces, with middle insert, structure lacquer. Substructure with 6 legs as well as cable routing module.	<b>Shipping</b>		on request
C12-420 for 12 people	Type / Design Dimension in cm	Color / Surface	Item number	Sales price
	<b>V-shape</b> with middle insert closed 421 x 212/284 x 74 (W x D x H)	<b>Melamine white, chipboard</b> Straight edge, for data connection panel with frame	10179	13.830 Euro
		<b>White, table top in MDF</b> data connection panel frameless possible	10180	18.700 Euro
		<b>Oak, table top in MDF</b> data connection panel frameless possible	10181	18.700 Euro
		<b>WhitePlex*</b> Straight edge, for data connection panel with frame	10183	23.840 Euro
	Table top 90 cm deep, 25 mm thick, chamfered edge, table top 5-pieces, with middle insert 2-pieces, structure lacquer. Substructure with 8 legs as well as 2 cable routings modules.	<b>Shipping</b>		on request
C12-500 for 14 people	Type / Design Dimension in cm	Color / Surface	Item number	Sales price
	<b>V-shape</b> with middle insert closed 500 x 212/298 x 74 (W x D x H)	<b>Melamine white, chipboard</b> Straight edge, for data connection panel with frame	10184	15.040 Euro
		<b>White, table top in MDF</b> data connection panel frameless possible	10185	20.450 Euro
		<b>Oak, table top in MDF</b> data connection panel frameless possible	10186	20.450 Euro
		<b>WhitePlex*</b> Straight edge, for data connection panel with frame	10188	26.640 Euro
	Table top 90 cm deep, 25 mm thick, chamfered edge, table top 5-pieces, with middle insert 2-pieces, structure lacquer. Substructure with 8 legs as well as 2 cable routing modules.	<b>Shipping</b>		on request

## Conference table\_C12

cutouts and data connection panels not included

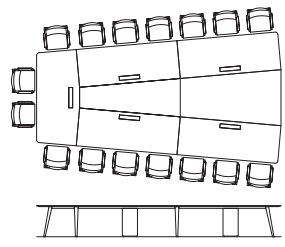
C12-580 for 16 people	Type / Design Dimension in cm	Color / Surface	Item number	Sales price
	<b>V-shape</b> with middle insert closed 580 x 212/312 x 74 (W x D x H)	<b>Melamine white, chipboard</b> Straight edge, for data connection panel with frame	10189	<b>16.990 Euro</b>
		<b>White, table top in MDF</b> data connection panel frameless possible	10190	<b>23.065 Euro</b>
		<b>Oak, table top in MDF</b> data connection panel frameless possible	10191	<b>23.065 Euro</b>
	Table top 90 cm deep, 25 mm thick, chamfered edge, table top 5-pieces, with middle insert 2-pieces, structure lacquer. Substructure with 8 legs as well as 2 cable routing modules.	<b>WhitePlex*</b> Straight edge, for data connection panel with frame	10193	<b>30.285 Euro</b>
		<b>Shipping</b>		<b>on request</b>

## Options conference table\_C12

Options	Color / Surface	Item number	Sales price	
<b>Cutout data connection panel</b> for free positioning according to specification. Only data panels with frames can be used with WhitePlex and melamine tops. Flush-mounted installation is technically impossible in this case.			on request	
<b>Sleeve for cable routing Ø 20 mm</b> for free positioning, includes milled hole in top and installation.	stainless steel	12037 11158 (WPX)	150 Euro 150 Euro	
<b>Grommet Ø 60 mm</b> for free positioning, incl. cutouts in body	plastic	white black	12038 12039	140 Euro 140 Euro
<b>Milled groove Qi Wireless Charger</b> Milled groove on underside of table can be freely positioned. Not available for WhitePlex tops.		10207	90 Euro	
<b>Magnetic metal blind</b> for cable routing along table leg.	black	10937 (corner foot) 10414 (midfoot)	170 Euro 170 Euro	
<b>Fabric tube</b> for routing the cable bundle to the floor outlet (up to 10 cables).	black	10209	140 Euro	
<b>Fabric cover</b> to cover the data connection panels on the underside of the table.	black	10936	140 Euro	
<b>Cable routing module</b> can be freely positioned below table top. For comfortable, invisible cable routing to floor connector as well as additional technology integration. Module equipped with maintenance hatch and feet.				
<ul style="list-style-type: none"> <li>· <b>Cable routing module 36</b>                Dimensions: 36 x 36 x 71 cm (W x D x H)</li> </ul>	arctic white lava black	10210 10211	625 Euro 625 Euro	
<ul style="list-style-type: none"> <li>· <b>Cable routing module 66</b>                Dimensions: 66 x 36 x 71 cm (W x D x H)</li> </ul>	arctic white lava black	10212 10213	840 Euro 840 Euro	
<b>Data connection panel / media flap</b>			on request	
<b>Delivery, set up and instruction by Holzmedia</b> In addition to simple Delivery At Place we also offer delivery including table installation. We especially recommend this for WhitePlex tops!			on request	





## General note / instruction

### Included in delivery / display mounts

All Elements furniture includes a mounting surface for commercially available display mounts complying with the VESA-Standard. The mounts themselves are not included in the scope of delivery.

### Pricelist / Prices

This price list renders prior price lists invalid.

The market prices are recommended retail prices and are intended to be realistically achievable by dealers. (Prices are net prices excl. VAT – in Euro)

For shipments in countries outside of EU additional importation VAT and customs charges will occur and have to be paid by the recipient.

We reserve the right of slight amendments in construction, design and dimensions of our products.

### Orders / Delivery

The delivered goods will be defined with the order confirmation.

Slight deviations in dimension, design or finish might be caused by the nature of our manufactured products. This doesn't justify any complaint, especially the identity of veneers and coatings can't be guaranteed. Re-orders included.

Wood is a natural product. Slight deviations of structure and color may occur and don't justify any complaint.

### Customized products

Customized products are possible after consultation with production and against additional charge. A cancellation of such orders is not possible. Changes to an on-going order are only possible after consulting with production and paying already completed production steps, which includes time spent on drawings, etc.

# General Terms and Conditions

## Holzmedia GmbH

### 1. General, scope of application

(1) All quotations, deliveries and other services by Holzmedia GmbH – present and future – are based solely on these terms and conditions. Counter-confirmations by customers based on their own business or purchasing policies are herewith rejected. Customer conditions that are different from or not mentioned in these General Terms and Conditions can only become part of a contractual agreement if we have accepted them in writing.

(2) Our General Terms and Conditions apply only to persons who, at the time of signing the contract, are exercising their commercial or independent professional activity (entrepreneurs) and to juristic persons under public law and to special funds under public law.

### 2. Conclusion of contract, self-supply reservation, re-exports

(1) Orders will become legally binding with our confirmation by e-mail, the content of which alone defines the contractual relationship as well as the scope of delivery and services. Subsidiary agreements, verbal explanations by employees or representatives as well as changes to confirmed orders (including changes to ordered items) need to be confirmed in writing by us in order to become valid.

(2) Our obligation to deliver is subject to the provision that we have received the required goods correctly and on time from our suppliers (self-supply reservation).

(3) All products delivered by us are intended to remain in the country of delivery, chosen by the customer. The re-export of our products is in principle subject to the foreign trade regulations of the Federal Republic of Germany or the country of origin, respectively, and might require the customer to apply for permission. It is the responsibility of the customer to find out about and comply with the applicable regulations.

### 3. Prices

(1) If not otherwise agreed, our prices apply ex works or warehouse, excluding packaging, shipping and insurance, as well as any VAT or customs duties that might apply.

(2) Prices are always valid for the corresponding order only – they do not apply to past or future orders.

(3) In case of contracts with agreed delivery periods longer than five weeks, both parties may demand a revision of the agreed price corresponding to changes in price-determining factors that are outside the influence of the contracting parties, such as decreases or increases of cost due to collective trade agreements or changes in the price of raw materials. Changes in price will be limited in scope to compensate for the increase or decrease in cost incurred. Either party shall also be entitled to demand a change in price if delays incurred by the other party cause delivery time to be longer than five weeks. A price change cannot be made if a fixed price agreement has been made in the contract.

### 4. Payment

(1) If not otherwise agreed, payments are to be made within 10 days of the invoice date and for the full net amount. Initial orders have to be paid in advance or cash on delivery. Payment is deemed complete only when we can freely dispose of the amount (receipt of payment).

(2) Bills of exchange and checks shall only be accepted provisionally on agreement from us, and are deemed valid payments only after the amount has been credited to our account. Bank fees, discount charges, stamp fees on bills of exchange as well as any other fees plus VAT shall be charged to the customer according to private bank rates.

(4) Any offsetting is only permitted in the case of accepted, undisputed claims or claims that have been awarded the customer through final legal judgment. The customer is only entitled to exercise a right of retention insofar as his counterclaim is based on the same contractual relationship and this counterclaim is recognised by us, is undisputed or has been established by a court of law.

### 5. Delivery period, acceptance of delivery, default of acceptance

(1) If a delivery period is part of the agreement, then this period begins with our order confirmation, but not before the customer has provided us with all necessary documents, permits and clearances as well as answers to all technical questions and details about the desired options that are required by the customer.

(2) The delivery period will be considered fulfilled if the conditions leading to transfer of risk described in section 6 have been fulfilled before its expiration.

(3) The delivery period will be extended appropriately – even in case of a delay in delivery – in the event of a force majeure and all other unforeseen hindrances occurring after conclusion of contract yet outside of our responsibility, insofar as these hindrances are proven to be relevant to furnishing the due service. This also applies if said hindrances occur to one of our suppliers. Beginning and end of such hindrances will be communicated to the customer as soon as possible. Should the hindrance last longer than three months or is certain to last longer than three months both the customer and we are entitled to withdraw from the contract.

(4) If the customer is in arrears with the acceptance of delivered items or payment, we may, after fruitless expiry of an appropriate legally required extension determined by us, withdraw from the contract and/or demand compensation instead of services. When

pressing claims for damages we can without further proof demand compensation amounting to 20 % of the purchase price to compensate lost profit if the delivered item is a standard product or 100 % of the purchase price if the delivered item is a custom-made product built to specific customer requests and we had expenditures for production and preparing delivery.

The right of the contract parties to prove higher or significantly lower actual damage remains unaffected. The regulations for evaluating damages stipulated by law also remain unaffected, as long as our side of the contract has been completely fulfilled. In the case of a delay in the acceptance of delivery by the customer we also remain the right to charge resulting additional expenditures, especially storage costs.

### 6. Delivery, shipping and transfer of risk

(1) All shipments are at the expense and risk of the customer.

(2) In the absence of specific agreements regarding shipment we will determine the most appropriate mode of shipment (without any guarantee for the safest, fastest or cheapest mode of shipment).

(3) Partial shipments and services are permissible to a reasonable extent.

(4) If the delivery item enters another member state of the European Community, customers are obliged to inform us before the shipment of their VAT identification number, which will be used for managing the shipment, as well as their branch of industry. The same is true for the inclusion of further states subject to the rules of this provision.

(5) For deliveries the risk is transferred to the customer from the moment the delivery items leave our factory or warehouse. This also applies to partial deliveries. If there is a delay in shipment that is not our responsibility, the risk is transferred to the customer with the notification of readiness for shipment.

### 7. Warranty

(1) The client's obligation to inspect and report any defects is regulated by section 377 of the German commercial code (HGB).

(2) The limitation period for material defect claims is 12 months calculated from the transfer of risk. The statutory limitation period shall apply to claims for damages in the event of intent and gross negligence as well as in the event of injury to life, limb and health which are based on an intentional or negligent breach of duty by the user.

(3) Should the delivered goods show a not insignificant defect, we are entitled, at our discretion, to remedy the defect or to deliver a defect-free item.

(4) There is no warranty for wear and tear, especially for parts subject to wear and tear. There is also no warranty for damage or malfunction of the delivered goods if said damage is the result of improper handling or unsuitable operating conditions.

(5) We will be liable for damaged goods or defects of delivered goods only within the limits described in section 8.

(6) If the default lies with a third-party product, we are entitled to assign our liability claim against our supplier to the customer, advising them to take the appropriate (legal) recourse. We will be liable according to paragraphs 3 and 5 only if the claims against our supplier despite timely (judicial) recourse cannot be enforced, or the recourse in the individual case constitutes an undue burden.

### 8. Liability

(1) All claims for damages and reimbursement of costs of the customer (hereinafter referred to as "claims for damages") against us on whatever legal grounds, including breach of duties in connection with the contract, due to culpa in contrahendo, due to other breaches of duty or claims in tort, are excluded.

(2) However, this exclusion of liability shall not apply if intentional or grossly negligent conduct by us or by one of our representatives, employees or other vicarious agents is the basis for the claim for damages; if damage culpably caused by us or by one of our representatives, employees or other vicarious agents due to injury to body, life or health is the basis for the claim for damages; as well as with regard to the liability which is mandatory by law, in particular under the German Product Liability Act, and in the event of a breach of warranty promises by us or if we or one of our representatives, employees or other vicarious agents negligently breach a material contractual obligation. If we have negligently breached a material contractual obligation and no other of the aforementioned grounds for liability applies, our liability shall be limited to the amount of damages that are usually foreseeable. An essential contractual obligation is a contractual obligation the fulfillment of which makes the proper performance of the contract possible in the first place and on the observance of which the customer regularly relies and may rely. In all other respects, insofar as liability is not excluded, the statutory provisions for the amount of liability shall apply.

(3) In the event that our liability is excluded or limited according to abovementioned conditions, this shall also apply to the personal liability of our staff, employees, factory workforce, legal representatives and agents.

(4) Claims of the customer against the seller become statute-barred one year after knowledge of the facts giving rise to the claim, at the latest, however, five years after performance of the service, unless liability is unlimited.

### 9. Retention of ownership and securities

(1) We reserve ownership of delivered items until the buyer has fulfilled all contractual obligations – including future obligations – towards us (including accessory claims such as currency exchange costs, interest). If the customer has reached a current account agreement with us, we reserve ownership until the complete settlement of the acknowledged balance. When a check or bill of exchange is received, settlement sets in when the check or bill of exchange has been cashed and we can freely dispose of the amount without risk of recourse. If we have agreed to reimburse the customer via check or bill of exchange, retention of ownership also extends until the check or bill of exchange written by us has been cashed by the customer and does not expire with the credit entry of the received check on our part.

(2) The customer may process and sell the goods in the due course of business, but may not pledge them or assign them as security to third parties.

(3) The customer is obliged to treat goods subject to retention with due care and insure them adequately and at his own expense against theft, destruction and damage. In case of seizure, impounding, damage or loss the customer has to inform us immediately. The customer will bear all costs, in particular those arising from third-party actions against execution of seizure or those arising from an eventual release from seizure, unless these can be collected from a third party.

(4) In case of default of payment or violation of other contractual agreements on the part of the customer we are entitled to temporarily retrieve the goods subject to retention. The use of the right of retrieval does not constitute a withdrawal from the contract.

(5) On purchase the customer assigns to us the price of purchase and other claims (including the acknowledged balance in case of a current account

agreement, or the existing causal account balance in case of insolvency of the customer's business partner) in the amount of the invoice value of the retained goods, in case of resale, further processing or other legal reasons (insurance claim, tort); we herewith accept such assignment. We hereby authorize the Customer revocably to collect claims assigned to us for his own account and in his own name. This power of collection may only be withdrawn if the purchaser does not meet his payments properly. In this case the customer is obliged to inform us on demand of the relevant indications concerning the assigned claims, furnish us with the relevant documentation and communicate the assignment to the debtor.

(6) The processing or reworking of the delivered goods by the purchaser will always be executed on our behalf. If the delivered objects are joined permanently with other objects, we will acquire co-ownership in the new object corresponding to the ratio of the value of the delivered object to the value of the other objects at the time of processing. For the new object created through processing the same rules apply as to the delivered object subject to retention. If the delivered object is joined to other objects to create a new object that we do not own in its entirety, it is agreed now that the ownership of the new object is partially assigned to us (i.e. corresponding to the ratio of the value of the delivered object to the value of the other objects at the time of processing). The customer will manage our coownership without remuneration. The new object is subject to the same rules as the object delivered.

(7) Where the value that can be realized from the securities due to us according to the above provisions permanently exceeds the value of our claims against the customer by more than 10 %, we will release corresponding securities of our own choosing on request from the customer. The abovementioned coverage limit of 110% will be increased inasmuch as we are charged VAT for the utilization of collateral because of a delivery including VAT on the part of customer by the amount of said VAT.

### 10. Final provisions

(1) The customer allows us, without notification, to use personal data within the provisions of the Federal data protection act as far as this is necessary for the conclusion of contract provisions.

(2) Unless otherwise agreed in writing, the place of fulfillment of delivery is Burgstetten, Germany.

(3) In so far as the customer is a merchant within the meaning of the German Commercial Code, legal person or special funds under public law, the court at the seat of the company shall be the legal forum for all disputes arising directly or indirectly from the contractual relationship, including disputes concerning checks or bills of exchange. The same is true if the customer doesn't have a general place of jurisdiction within the Federal Republic of Germany or has transferred his place of residence or habitual abode to a country other than Germany after conclusion of the contract, or if the Customer's residence or habitual abode is unknown when the legal action is filed. We are however entitled to initiate legal proceedings against the customer at his own place of jurisdiction.

(4) The law of the Federal Republic of Germany under exclusion of the UN-purchase right shall be applicable for these General Terms and Conditions and the overall legal relation between the customer and us.

(5) Should individual provisions of the contract be or become ineffective or contain a loophole, the remaining provisions shall remain unaffected. The parties undertake to replace the invalid provision with a legally permissible provision that comes as close as possible to the economic purpose of the invalid provision or fills this gap.



Holzmedia

Contact

Holzmedia GmbH Office

Neue Straße 10 D-71576 Burgstetten

T +49 (0)71 91 34 47-0

info@holzmedia.de www.holzmedia.de

Holzmedia GmbH Showroom

Rathausstraße 61 D-71576 Burgstetten