

## Media column\_W8 M

for 55" to 65" displays  
with up to 60 kg weight

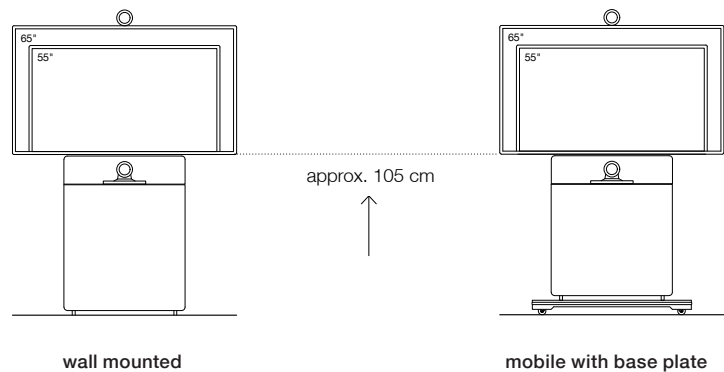

### VC camera position:

above display (height variable from 180 cm upward)  
or below display (height about 85 cm)

### Type / Design

One door – with textile cover for external speakers in black.  
Body and door made of MDF, finished with structured varnish.  
Passive body ventilation for individual technology integration.  
Prepared for the integration of a video conference system. Display mount not included.

### Dimensions (W x D x H)

Furniture, outside (base plate)	800 x 220 x 1750 mm	800 (1050) x 220 (550) x 1750 (100) mm
Technology housing (*fittings not included)	650 x 180* x 800 mm	650 x 180* x 720 mm
Speaker housing	620 x 180 x 165 mm	620 x 180 x 165 mm

### Requirements for display integration

- max. display width	1600 mm	1600 mm
- max. display weight	60 kg	60 kg
- recom. display depth (incl. mount)	80 - 100 mm	80 - 100 mm
- space for display mount (W x H)	700 x 700 mm	700 x 700 mm
- recess for display and mount	80 mm	80 mm
- height of the display's lower edge	1050 mm	1050 mm

### Color\*\* / Item number

arctic white	10010	10012
lava black	10011	10013

### Base price for 1 unit

2.880 Euro ↑

3.840 Euro ↑

excluding transportation

(order of 3 or more = scaled conditions!)

on request

on request

### Shipping

on request

Options	Surface / Color	Item number	Sales price
<b>VC camera mount</b>			
- for position above display, space 240 x 150 mm (W x D)	metal, powder coated, black	10033	190 Euro
- for position in front of speaker cover, space 250 x 200 mm (W x D)	metal, powder coated, black	10034	190 Euro
<b>Customized bezel for VC systems / cameras</b>			
for example for Cisco Webex Room Kit Mini / Logitech Meet up / etc. incl. mounting substructure	structured varnish arctic white	10571	390 Euro
This bezel replaces the speaker covers of the main product.	structured varnish lava black	10704	390 Euro
<b>Door lock (per door/piece)</b>	nickel-plated, matt	10035	150 Euro
<b>Shelf for technology housing</b>			
	structured varnish arctic white	10028	40 Euro
	structured varnish lava black	10664	40 Euro
<b>Cable roll holder</b>			
on the back side of the mobile version	structured varnish arctic white	10036	140 Euro
	structured varnish lava black	10665	140 Euro

\*\* Structured varnish colors can be customized on-request against surcharge.

Prices = net sales prices, excluding VAT (in Euro)

↑ = increased prices

## Media column\_W8 L

for 70" to 80" displays  
with up to 80 kg weight

### VC camera position:

above display (height variable from ca. 210 cm upward)  
or below display (height about 102 cm)

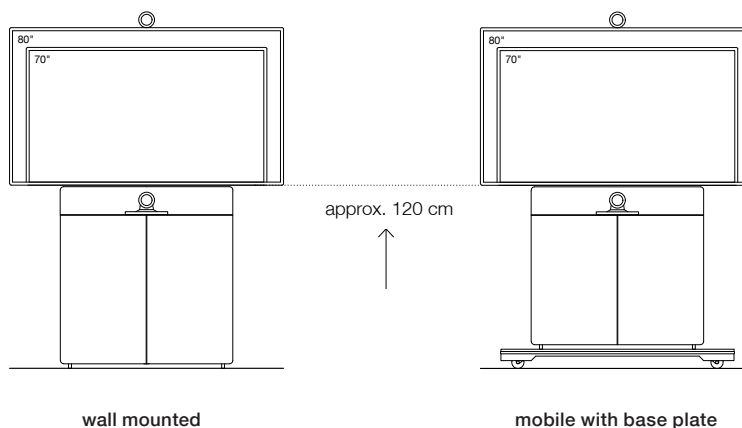

### Type / Design

Two doors – with textile cover for external speakers in black.  
Body and door made of MDF, finished with structured varnish.  
Passive body ventilation for individual technology integration.

Prepared for the integration of a video conference system. Display mount not included.

### Dimensions (W x D x H)

Furniture, outside (base plate)	1140 x 250 x 1960 mm	1140 (1540) x 250 (650) x 1960 (130) mm
Technology housing (*fittings not included)	2 x 480 x 210* x 950 mm	2 x 480 x 210* x 840 mm
Speaker housing	960 x 210 x 165 mm	960 x 210 x 165 mm

### Requirements for display integration

- max. display width	1900 mm	1900 mm
- max. display weight	80 kg	80 kg
- recom. display depth (incl. mount)	110 - 130 mm	110 - 130 mm
- space for display mount (W x H)	1040 x 760 mm	1040 x 760 mm
- recess for display and mount	110 mm	110 mm
- height of the display's lower edge	1200 mm	1200 mm

### Color\*\* / Item number

arctic white	10014	10016
lava black	10015	10017

### Base price for 1 unit

excluding transportation	3.760 Euro ↑	5.090 Euro ↑
(order of 3 or more = scaled conditions!)	on request	on request

### Shipping

on request

Options	Surface / Color	Item number	Sales price
<b>VC camera housing below display</b>	structured varnish arctic white	10667	390 Euro
with centrally divided speaker cover, dimensions 340 x 210 x 180 mm (W x D x H)	structured varnish lava black	10671	390 Euro
<b>VC camera mount</b>			
- for position above display, space 240 x 150 mm (W x D)	metal, powder coated, black	10033	190 Euro
- for position in front of speaker cover, space 250 x 200 mm (W x D)	metal, powder coated, black	10034	190 Euro
<b>Customized bezel for VC systems / cameras</b>	structured varnish arctic white	10705	390 Euro
for example for Cisco Webex Room Kit Mini / Logitech Meet up / etc. incl. mounting substructure	structured varnish lava black	10706	390 Euro
This bezel replaces the speaker covers of the main product.			
<b>Door lock (per door/piece)</b>	nickel-plated, matt	10035	150 Euro
<b>Shelf for technology housing</b>	structured varnish arctic white	10029	40 Euro
	structured varnish lava black	10666	40 Euro
<b>Cable roll holder</b>	structured varnish arctic white	10036	140 Euro
on the back side of the mobile version	structured varnish lava black	10665	140 Euro

\*\* Structured varnish colors can be customized on request against surcharge.

Prices = net sales prices, excluding VAT (in Euro)

↑ = increased prices

Holzmedia GmbH

## Media column\_W8 XL

for 84" to 98" displays  
with up to 100 kg weight

### VC camera position:

below display (height about 102 cm)

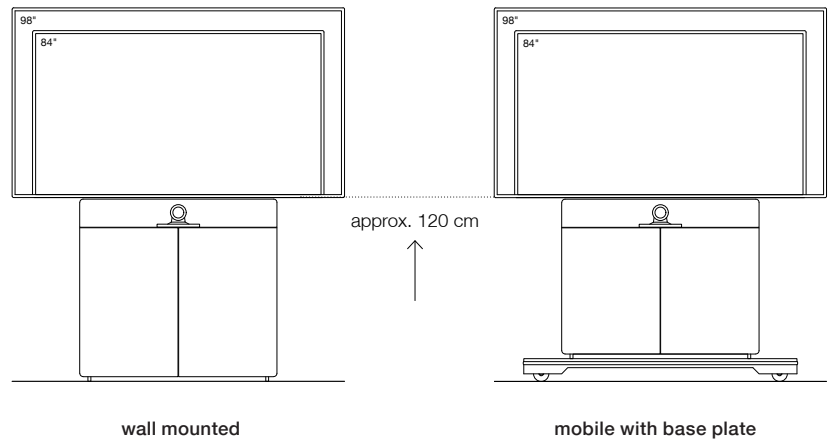

### Type / Design

Two doors – with textile cover for external speakers in black.  
Body and door made of MDF, finished with structured varnish.  
Passive body ventilation for individual technology integration.  
Prepared for the integration of a video conference system. Display mount not included.

### Dimensions (W x D x H)

Furniture, outside (base plate)	1300 x 280 x 2070 mm	1300 (1800) x 280 (700) x 2070 (150) mm
Technology housing (*fittings not included)	2 x 560 x 240* x 950 mm	2 x 560 x 240* x 820 mm
Speaker housing	1120 x 240 x 165 mm	1120 x 240 x 165 mm

### Requirements for display integration

- max. display width	2280 mm	2280 mm
- max. display weight	100 kg	100 kg
- recom. display depth (incl. mount)	130 - 150 mm	130 - 150 mm
- space for display mount (W x H)	1200 x 870 mm	1200 x 870 mm
- recess for display and mount	130 mm	130 mm
- height of the display's lower edge	1200 mm	1200 mm

### Color\*\* / Item number

arctic white	10018	10020
lava black	10019	10021

### Base price for 1 unit

4.460 Euro ↑

6.260 Euro ↑

excluding transportation

(order of 3 or more = scaled conditions!)

on request

on request

### Shipping

on request

Options	Surface / Color	Item number	Sales price
<b>VC camera housing below display*</b> with centrally divided speaker cover, dimensions 340 x 240 x 180 mm (W x D x H)	structured varnish arctic white	10668 * 10647	390 Euro
	structured varnish lava black	10669 * 10692	390 Euro
<b>* for Logitech Rally Plus system (180 x 240 x 180 mm)</b>			
<b>VC camera mount</b> for position in front of speaker cover, space 250 x 200 mm (W x D)	metal, powder coated, black	10034	190 Euro
<b>Customized bezel for VC systems / cameras</b> for example for Cisco Webex Room Kit Mini / Logitech Meet up / etc. incl. mounting substructure This bezel replaces the speaker covers of the main product.	structured varnish arctic white	10707	390 Euro
	structured varnish lava black	10708	390 Euro
<b>Door lock (per door/piece)</b>	nickel-plated, matt	10035	150 Euro
<b>Shelf for technology housing</b>	structured varnish arctic white	10030	40 Euro
	structured varnish lava black	10670	40 Euro
<b>Cable roll holder</b> on the back side of the mobile version	structured varnish arctic white	10036	140 Euro
	structured varnish lava black	10665	140 Euro

\*\* Structured varnish colors can be customized on request against surcharge.

Prices = net sales prices, excluding VAT (in Euro)

↑ = increased prices

Holzmedia GmbH

# Media column\_W8 M<sup>2</sup>

for 55" to 65" displays  
with each up to 60 kg weight

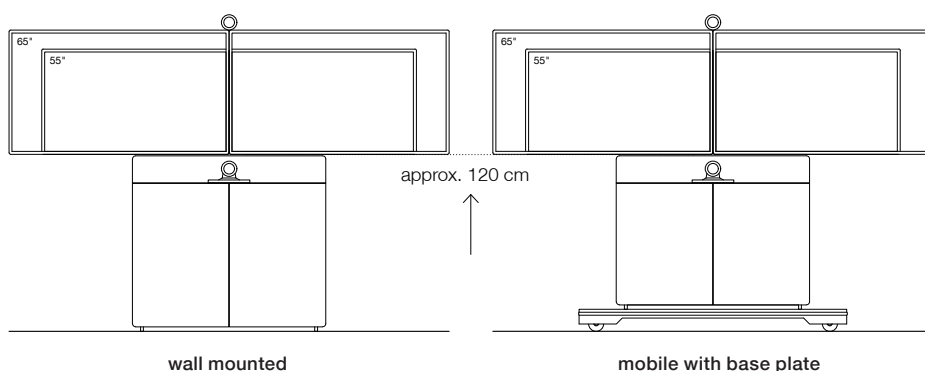

## VC camera position:

above display (height variable from 195 cm upward)  
or below display (height about 102 cm)

## Type / Design

Two doors – with textile cover for external speakers in black.  
Body and door made of MDF, finished with structured varnish.  
Passive body ventilation for individual technology integration.

Prepared for the integration of a video conference system. Display mount not included.

## Dimensions (W x D x H)

Furniture, outside (base plate)	1300 x 280 x 1900 mm	1300 (1800) x 280 (700) x 1900 (150) mm
Technology housing (*fittings not included)	2 x 560 x 240* x 950 mm	2 x 560 x 240* x 820 mm
Speaker housing	1120 x 240 x 165 mm	1120 x 240 x 165 mm

## Requirements for display integration

- max. display width	1600 mm	1600 mm
- max. display weight	60 kg	60 kg
- recom. display depth (incl. mount)	80 - 100 mm	80 - 100 mm
- space for display mount (W x H)	2200 x 650 mm	2200 x 650 mm
- recess for display and mount	80 mm	80 mm
- height of the display's lower edge	1200 mm	1200 mm

## Color\*\* / Item number

arctic white	10022	10024
lava black	10023	10025

## Base price for 1 unit

4.760 Euro ↑

6.570 Euro ↑

excluding transportation

(order of 3 or more = scaled conditions!)

on request

on request

## Shipping

on request

Options	Surface / Color	Item number	Sales price
<b>VC camera housing below display*</b> with centrally divided speaker cover, dimensions 340 x 240 x 180 mm (W x D x H)	structured varnish arctic white	10672 * 10720	390 Euro
	structured varnish lava black	10673 * 10678	390 Euro
<b>* for Logitech Rally Plus system (180 x 240 x 180 mm)</b>			
<b>VC camera mount</b> - for position above display, space 240 x 150 mm (W x D) - for position in front of speaker cover, space 250 x 200 mm (W x D)	metal, powder coated, black	10033	190 Euro
	metal, powder coated, black	10034	190 Euro
<b>Customized bezel for VC systems / cameras</b> for example for Cisco Webex Room Kit Mini / Logitech Meet up / etc. incl. mounting substructure This bezel replaces the speaker covers of the main product.	structured varnish arctic white	10709	390 Euro
	structured varnish lava black	10710	390 Euro
<b>Door lock (per door/piece)</b>	nickel-plated, matt	10035	150 Euro
<b>Shelf for technology housing</b>	structured varnish arctic white	10031	40 Euro
	structured varnish lava black	10674	40 Euro
<b>Cable roll holder</b> on the back side of the mobile version	structured varnish arctic white	10036	140 Euro
	structured varnish lava black		

\*\* Structured varnish colors can be customized on request against surcharge.

Prices = net sales prices, excluding VAT (in Euro)

↑ = increased prices

Holzmedia GmbH

## Media column\_W8 L<sup>2</sup>

for 70" to 80" displays  
with each up to 80 kg weight

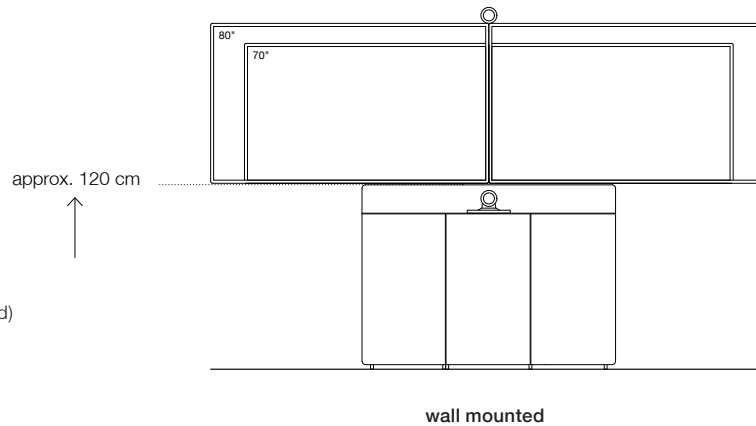

### VC camera position:

above display (height variable from 210 cm upward)  
or below display (height about 102 cm)

### Type / Design

Three doors – with textile cover for external speakers in black.  
Body and door made of MDF, finished with structured varnish.  
Passive body ventilation for individual technology integration.  
Prepared for the integration of a video conference system. Display mount not included.

### Dimensions (W x D x H)

Furniture, outside (base plate)	1650 x 310 x 1960 mm
Technology housing (*fittings not included)	2 x 450 x 270* x 950 mm 1 x 520 x 270* x 950 mm
Speaker housing	2 x 430 x 270 x 165 mm

### Requirements for display integration

- max. display width	1900 mm
- max. display weight	80 kg
- recom. display depth (incl. mount)	110 - 130 mm
- space for display mount (W x H)	2850 x 710 mm
- recess for display and mount	110 mm
- height of the display's lower edge	1200 mm

### Color\*\* / Item number

arctic white	10026
lava black	10027

### Base price for 1 unit

excluding transportation	6.240 Euro ↑
(order of 3 or more = scaled conditions!)	on request

### Shipping

on request

Options	Surface / Color	Item number	Sales price
<b>VC camera housing below display</b>	structured varnish arctic white	10675	390 Euro
with centrally divided speaker cover, dimensions 340 x 270 x 180 mm (W x D x H)	structured varnish lava black	10676	390 Euro
<b>VC camera mount</b>			
- for position above display, space 240 x 150 mm (W x D)	metal, powder coated, black	10033	190 Euro
- for position in front of speaker cover, space 250 x 200 mm (W x D)	metal, powder coated, black	10034	190 Euro
<b>Customized bezel for VC systems / cameras</b>	structured varnish arctic white	10711	390 Euro
for example for Cisco Webex Room Kit Mini / Logitech Meet up / etc. incl. mounting substructure	structured varnish lava black	10712	390 Euro
This bezel replaces the speaker covers of the main product.			
<b>Door lock (per door/piece)</b>	nickel-plated, matt	10035	150 Euro
<b>Shelf for technology housing</b>	structured varnish arctic white	L:10032, M:10682, R:10683	40 Euro
	structured varnish lava black	L:10677, M:10684, R:10685	40 Euro

\*\* Structured varnish colors can be customized on request against surcharge.

Prices = net sales prices, excluding VAT (in Euro)

↑ = increased prices

## Media column\_W8 L<sup>2</sup>

for 70" to 80" displays  
with each up to 80 kg weight

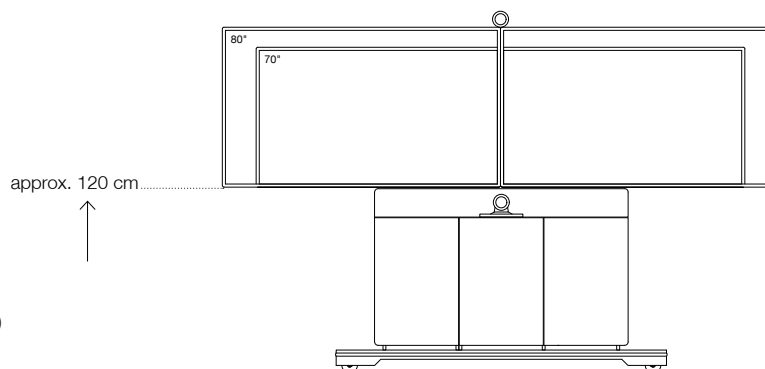

mobile with base plate

### Type / Design

Three doors – with textile cover for external speakers in black.  
Body and door made of MDF, finished with structured varnish.  
Passive body ventilation for individual technology integration.  
Prepared for the integration of a video conference system. Display mount not included.

### Dimensions (W x D x H)

Furniture, outside (base plate)	1650 (2150) x 310 (700) x 1960 (150) mm
Technology housing (*fittings not included)	2 x 450 x 270* x 820 mm 1 x 520 x 270* x 820 mm
Speaker housing	2 x 430 x 270 x 165 mm

### Requirements for display integration

- max. display width	1900 mm
- max. display weight	80 kg
- recom. display depth (incl. mount)	110 - 130 mm
- space for display mount (W x H)	2850 x 710 mm
- recess for display and mount	110 mm
- height of the display's lower edge	1200 mm

### Color\*\* / Item number

arctic white	10651
lava black	10652

### Base price for 1 unit

excluding transportation	8.680 Euro ↑
(order of 3 or more = scaled conditions!)	on request

### Shipping

on request

Options	Surface / Color	Item number	Sales price
<b>VC camera housing below display</b>	structured varnish arctic white	10675	390 Euro
with centrally divided speaker cover, dimensions 340 x 270 x 180 mm (W x D x H)	structured varnish lava black	10676	390 Euro
<b>VC camera mount</b>			
- for position above display, space 240 x 150 mm (W x D)	metal, powder coated, black	10033	190 Euro
- for position in front of speaker cover, space 250 x 200 mm (W x D)	metal, powder coated, black	10034	190 Euro
<b>Customized bezel for VC systems / cameras</b>	structured varnish arctic white	10711	390 Euro
for example for Cisco Webex Room Kit Mini / Logitech Meet up / etc. incl. mounting substructure	structured varnish lava black	10712	390 Euro
This bezel replaces the speaker covers of the main product.			
<b>Door lock (per door/piece)</b>	nickel-plated, matt	10035	150 Euro
<b>Shelf for technology housing</b>	structured varnish arctic white	L:10032, M:10682, R:10683	40 Euro
	structured varnish lava black	L:10677, M:10684, R:10685	40 Euro
<b>Cable roll holder</b>	structured varnish arctic white	10036	140 Euro
on the back side of the mobile version	structured varnish lava black	10665	140 Euro

\*\* Structured varnish colors can be customized on request against surcharge.

Prices = net sales prices, excluding VAT (in Euro)

↑ = increased prices

Holzmedia GmbH

# Media column\_W8 XL<sup>2</sup>

for 84" to 98" displays  
with each up to 100 kg weight

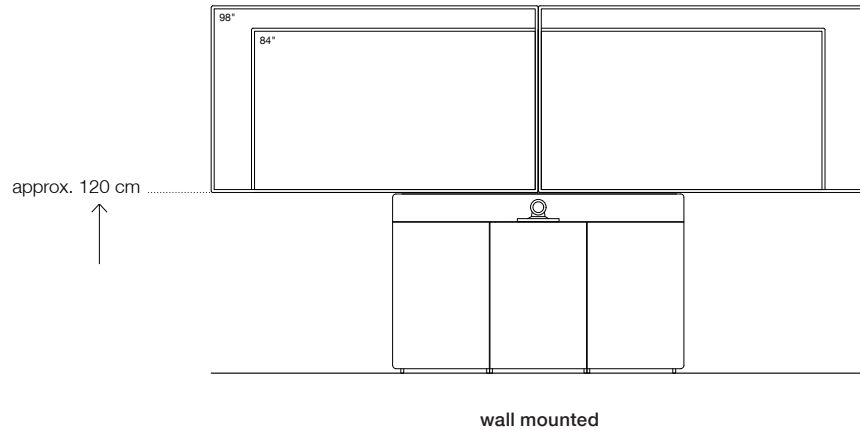

**VC camera position:**  
below display (height about 102 cm)

## Type / Design

Three doors – with textile cover for external speakers in black.  
Body and door made of MDF, finished with structured varnish.  
Passive body ventilation for individual technology integration.  
Prepared for the integration of a video conference system. Display mount not included.

## Dimensions (W x D x H)

Furniture, outside (base plate)	1950 x 310 x 2070 mm
Technology housing (*fittings not included)	2 x 550 x 270* x 950 mm 1 x 610 x 270* x 950 mm
Speaker housing	2 x 520 x 270 x 165 mm

## Requirements for display integration

- max. display width	2280 mm
- max. display weight	100 kg
- recom. display depth (incl. mount)	130 - 150 mm
- space for display mount (W x H)	3400 x 820 mm
- recess for display and mount	130 mm
- height of the display's lower edge	1200 mm

## Color\*\* / Item number

arctic white	<b>10653</b>
lava black	<b>10654</b>

## Base price for 1 unit

excluding transportation	<b>7.320 Euro</b> ↑
(order of 3 or more = scaled conditions!)	on request

## Shipping

on request

Options	Surface / Color	Item number	Sales price
<b>VC camera housing below display</b> with centrally divided speaker cover, dimensions 340 x 270 x 180 mm (W x D x H)	structured varnish arctic white	10679	390 Euro
	structured varnish lava black	10680	390 Euro
<b>VC camera mount</b> for position in front of speaker cover, space 250 x 200 mm (W x D)	metal, powder coated, black	10034	190 Euro
<b>Customized bezel for VC systems / cameras</b> for example for Cisco Webex Room Kit Mini / Logitech Meet up / etc. incl. mounting substructure This bezel replaces the speaker covers of the main product.	structured varnish arctic white	10713	390 Euro
	structured varnish lava black	10714	390 Euro
<b>Door lock (per door/piece)</b>	nickel-plated, matt	10035	150 Euro
<b>Shelf for technology housing</b>	structured varnish arctic white	L+R:10681, M:10686	40 Euro
	structured varnish lava black	L+R:10687, M:10688	40 Euro

\*\* Structured varnish colors can be customized on request against surcharge.

Prices = net sales prices, excluding VAT (in Euro)

↑ = increased prices

## Media column\_W8 XL<sup>2</sup>

for 84" to 98" displays  
with each up to 100 kg weight

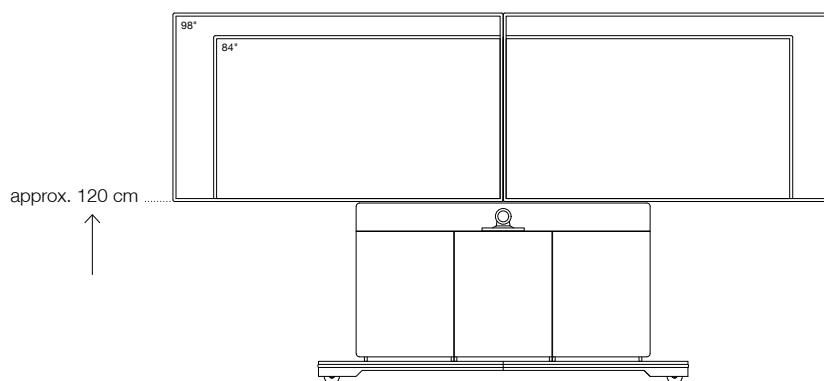

mobile with base plate

**VC camera position:**  
below display (height about 102 cm)

### Type / Design

Three doors – with textile cover for external speakers in black.  
Body and door made of MDF, finished with structured varnish.  
Passive body ventilation for individual technology integration.  
Prepared for the integration of a video conference system. Display mount not included.

### Dimensions (W x D x H)

Furniture, outside (base plate)

1950 (2450) x 310 (750) x 2070 (150) mm

Technology housing (\*fitting not included)

2 x 550 x 270\* x 820 mm

1 x 610 x 270\* x 820 mm

Speaker housing

2 x 520 x 270 x 165 mm

### Requirements for display integration

- max. display width	2280 mm
- max. display weight	100 kg
- recom. display depth (incl. mount)	130 - 150 mm
- space for display mount (W x H)	3400 x 820 mm
- recess for display and mount	130 mm
- height of the display's lower edge	1200 mm

### Color\*\* / Item number

arctic white	10655
lava black	10656

### Base price for 1 unit

9.970 Euro ↑

excluding transportation

(order of 3 or more = scaled conditions!)

on request

### Shipping

on request

Options	Surface / Color	Item number	Sales price
<b>VC camera housing below display</b>	structured varnish arctic white	10679	390 Euro
with centrally divided speaker cover, dimensions 340 x 270 x 180 mm (W x D x H)	structured varnish lava black	10680	390 Euro
<b>VC camera mount</b>	metal, powder coated, black	10034	190 Euro
for position in front of speaker cover, space 250 x 200 mm (W x D)			
<b>Customized bezel for VC systems / cameras</b>	structured varnish arctic white	10713	390 Euro
for example for Cisco Webex Room Kit Mini / Logitech Meet up / etc. incl. mounting substructure	structured varnish lava black	10714	390 Euro
This bezel replaces the speaker covers of the main product.			
<b>Door lock (per door/piece)</b>	nickel-plated, matt	10035	150 Euro
<b>Shelf for technology housing</b>	structured varnish arctic white	L+R:10681, M:10686	40 Euro
	structured varnish lava black	L+R:10687, M:10688	40 Euro
<b>Cable roll holder</b>	structured varnish arctic white	10036	140 Euro
on the back side of the mobile version	structured varnish lava black	10665	140 Euro

\*\* Structured varnish colors can be customized on request against surcharge.

Prices = net sales prices, excluding VAT (in Euro)

↑ = increased prices



## General elements options

Options	Surface / Color		Item number	Sales price
<b>Custom structured varnish colors</b> according to specification in RAL or NCS color system		single per order	10527	390 Euro
<b>Custom cutouts</b> for free positioning of keypads, control panels or connector panels.		1. piece every further, identical		190 Euro 95 Euro
<b>Custom drilled holes of up to 68 mm</b> for free positioning of switches, sockets, outlets etc.		1. piece every further, identical	10091 10578	90 Euro 45 Euro
<b>Cable passage Ø 60 mm</b> for free positioning, incl. cutouts in body	plastic	1. piece every further, identical	10574 10719	120 Euro 60 Euro
<b>Height and depth customization</b> furniture body can be customized up to - 300 mm in height - 100 mm in depth			10659	10% surcharge on the base item
<b>Custom cabinet adjustment / lateral cutout</b> for placement of VC soundbars without bezel (e.g. for Fohhn Scale Bar and Crestron VC-SB1 in W8 M or L)			10776	10% surcharge on the base item
<b>19-inch rack – 4HU</b> for vertical mounting of 19-inch devices in a media column. Easy cable routing and maintenance through integrated mounting and swivel mechanism 520 x 205 x 195 mm (W x H x D) <u>Attention:</u> For space reasons the use of the rack is not possible in the W8 M and L - as well as in all S1. In the W8 L <sup>2</sup> the rack fits only in the center cabinet.	metal, powder coated, black		10442	290 Euro
Delivery, set up and instruction by Holzmedia			10259	on request

## Replacement bezel plates for media column\_W8 new

Replacement bezel plates	Surface / Color**	Sales price
<b>Speaker cover standard</b> spare part as in the main product	acoustic fabric black, back lacquered with structured varnish	
Size M		390 Euro
Size L		490 Euro
Size XL		590 Euro
Size M <sup>2</sup>		590 Euro
Size L <sup>2</sup>		690 Euro
Size XL <sup>2</sup>		790 Euro
<b>Custom speaker cover</b> with custom cutout	acoustic fabric black, back lacquered in structured varnish arctic white or structured varnish lava black	
Size M		590 Euro
Size L		690 Euro
Size XL		790 Euro
Size M <sup>2</sup>		790 Euro
Size L <sup>2</sup>		890 Euro
Size XL <sup>2</sup>		990 Euro
<b>Custom VC bezel plate</b> with cutout and mounting device for VC soundbar	made of MDF in structured varnish arctic white or structured varnish lava black	
Size M		590 Euro
Size L		690 Euro
Size XL		790 Euro
Size M <sup>2</sup>		790 Euro
Size L <sup>2</sup>		890 Euro
Size XL <sup>2</sup>		990 Euro
<b>VC camera housing below display</b> with centrally divided speaker cover	structured varnish arctic white or lava black acoustic fabric black	
Size L		690 Euro
Size XL		790 Euro
Size M <sup>2</sup>		790 Euro
Size L <sup>2</sup>		890 Euro
Size XL <sup>2</sup>		990 Euro

\*\* Structured varnish colors can be customized on request against surcharge.

Prices = net sales prices, excluding VAT (in Euro)