

Media column_W8 M

for 55" to 65" displays
with up to 60 kg weight

VC camera position:

above display (height variable from 180 cm upward)
or below display (height about 85 cm)

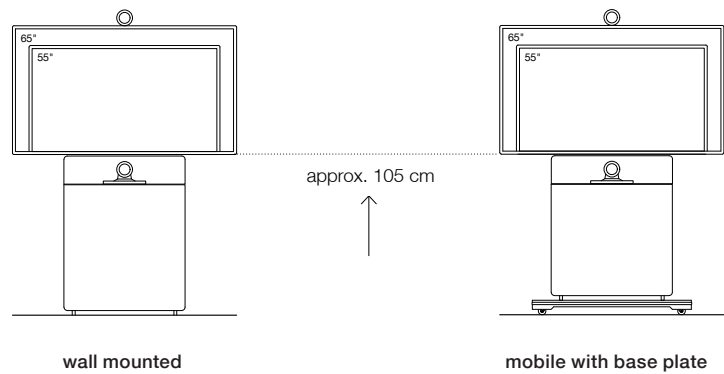

Type / Design

One door – with textile cover for external speakers in black.
Body and door made of MDF, finished with structured varnish.
Passive body ventilation for individual technology integration.
Prepared for the integration of a video conference system. Display mount not included.

Dimensions (W x D x H)

Furniture, outside (base plate)	800 x 220 x 1750 mm	800 (1050) x 220 (550) x 1750 (100) mm
Technology housing (*fittings not included)	650 x 180* x 800 mm	650 x 180* x 720 mm
Speaker housing	620 x 180 x 165 mm	620 x 180 x 165 mm

Requirements for display integration

- max. display width	1600 mm	1600 mm
- max. display weight	60 kg	60 kg
- recom. display depth (incl. mount)	80 - 100 mm	80 - 100 mm
- space for display mount (W x H)	700 x 700 mm	700 x 700 mm
- recess for display and mount	80 mm	80 mm
- height of the display's lower edge	1050 mm	1050 mm

Color** / Item number

arctic white	10010	10012
lava black	10011	10013

Base price for 1 unit

	2.740 Euro	3.660 Euro
excluding transportation		
(order of 3 or more = scaled conditions!)	on request	on request

Shipping

on request

Options	Surface / Color	Item number	Sales price
VC camera mount			
- for position above display, space 240 x 150 mm (W x D)	metal, powder coated, black	10033	190 Euro
- for position in front of speaker cover, space 250 x 200 mm (W x D)	metal, powder coated, black	10034	190 Euro
Customized bezel for VC systems / cameras			
for example for Cisco Webex Room Kit Mini / Logitech Meet up / etc. incl. mounting substructure	structured varnish arctic white	10571	390 Euro
This bezel replaces the speaker covers of the main product.	structured varnish lava black	10704	390 Euro
Door lock (per door/piece)	nickel-plated, matt	10035	148 Euro
Shelf for technology housing	structured varnish arctic white	10028	40 Euro
	structured varnish lava black	10664	40 Euro
Cable roll holder	structured varnish arctic white	10036	140 Euro
on the back side of the mobile version	structured varnish lava black	10665	140 Euro

Media column_W8 L

for 70" to 80" displays
with up to 80 kg weight

VC camera position:

above display (height variable from ca. 210 cm upward)
or below display (height about 102 cm)

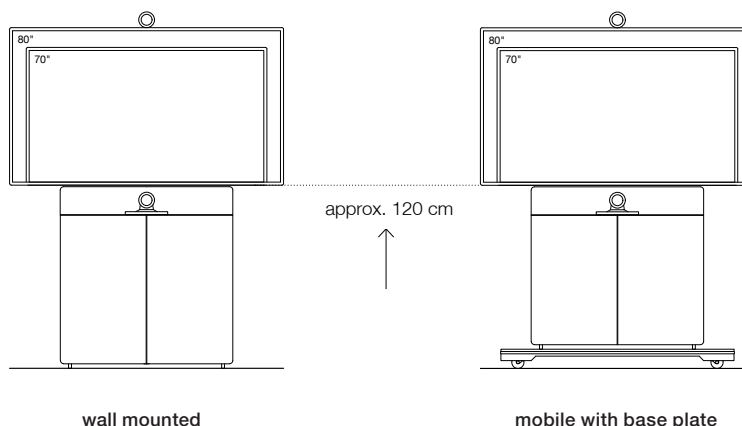

Type / Design

Two doors – with textile cover for external speakers in black.
Body and door made of MDF, finished with structured varnish.
Passive body ventilation for individual technology integration.

Prepared for the integration of a video conference system. Display mount not included.

Dimensions (W x D x H)

Furniture, outside (base plate)	1140 x 250 x 1960 mm	1140 (1540) x 250 (650) x 1960 (130) mm
Technology housing (*fittings not included)	2 x 480 x 210* x 950 mm	2 x 480 x 210* x 840 mm
Speaker housing	960 x 210 x 165 mm	960 x 210 x 165 mm

Requirements for display integration

- max. display width	1900 mm	1900 mm
- max. display weight	80 kg	80 kg
- recom. display depth (incl. mount)	110 - 130 mm	110 - 130 mm
- space for display mount (W x H)	1040 x 760 mm	1040 x 760 mm
- recess for display and mount	110 mm	110 mm
- height of the display's lower edge	1200 mm	1200 mm

Color** / Item number

arctic white	10014	10016
lava black	10015	10017

Base price for 1 unit

excluding transportation	3.580 Euro	4.860 Euro
(order of 3 or more = scaled conditions!)	on request	on request

Shipping

on request

Options	Surface / Color	Item number	Sales price
VC camera housing below display	structured varnish arctic white	10667	390 Euro
with centrally divided speaker cover, dimensions 340 x 210 x 180 mm (W x D x H)	structured varnish lava black	10671	390 Euro
VC camera mount			
- for position above display, space 240 x 150 mm (W x D)	metal, powder coated, black	10033	190 Euro
- for position in front of speaker cover, space 250 x 200 mm (W x D)	metal, powder coated, black	10034	190 Euro
Customized bezel for VC systems / cameras	structured varnish arctic white	10705	390 Euro
for example for Cisco Webex Room Kit Mini / Logitech Meet up / etc. incl. mounting substructure	structured varnish lava black	10706	390 Euro
This bezel replaces the speaker covers of the main product.			
Door lock (per door/piece)	nickel-plated, matt	10035	148 Euro
Shelf for technology housing	structured varnish arctic white	10029	40 Euro
	structured varnish lava black	10666	40 Euro
Cable roll holder	structured varnish arctic white	10036	140 Euro
on the back side of the mobile version	structured varnish lava black	10665	140 Euro

** Structured varnish colors can be customized on request against surcharge.
Prices = net sales prices, excluding VAT (in Euro)

Media column_W8 XL

for 84" to 98" displays
with up to 100 kg weight

VC camera position:

below display (height about 102 cm)

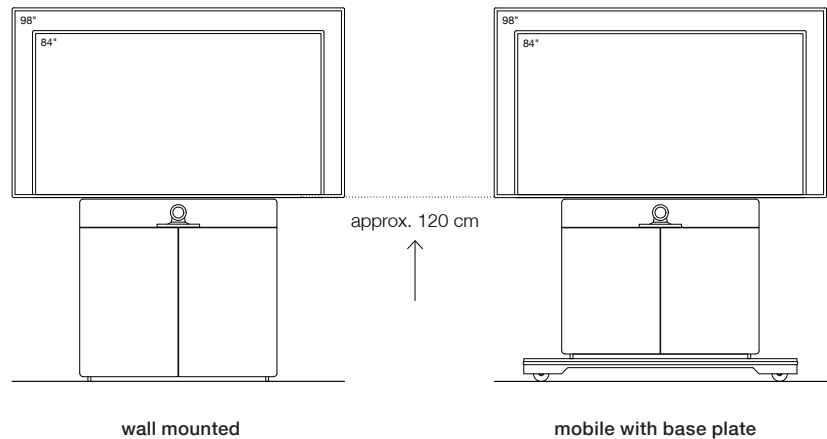

Type / Design

Two doors – with textile cover for external speakers in black.
Body and door made of MDF, finished with structured varnish.
Passive body ventilation for individual technology integration.
Prepared for the integration of a video conference system. Display mount not included.

Dimensions (W x D x H)

Furniture, outside (base plate)	1300 x 280 x 2070 mm	1300 (1800) x 280 (700) x 2070 (150) mm
Technology housing (*fittings not included)	2 x 560 x 240* x 950 mm	2 x 560 x 240* x 820 mm
Speaker housing	1120 x 240 x 165 mm	1120 x 240 x 165 mm

Requirements for display integration

- max. display width	2280 mm	2280 mm
- max. display weight	100 kg	100 kg
- recom. display depth (incl. mount)	130 - 150 mm	130 - 150 mm
- space for display mount (W x H)	1200 x 870 mm	1200 x 870 mm
- recess for display and mount	130 mm	130 mm
- height of the display's lower edge	1200 mm	1200 mm

Color** / Item number

arctic white	10018	10020
lava black	10019	10021

Base price for 1 unit

4.250 Euro

5.960 Euro

excluding transportation

(order of 3 or more = scaled conditions!)

on request

on request

Shipping

on request

Options	Surface / Color	Item number	Sales price
VC camera housing below display with centrally divided speaker cover, dimensions 340 x 240 x 180 mm (W x D x H)	structured varnish arctic white	10668	390 Euro
	structured varnish lava black	10669	390 Euro
VC camera mount for position in front of speaker cover, space 250 x 200 mm (W x D)	metal, powder coated, black	10034	190 Euro
Customized bezel for VC systems / cameras for example for Cisco Webex Room Kit Mini / Logitech Meet up / etc. incl. mounting substructure This bezel replaces the speaker covers of the main product.	structured varnish arctic white	10707	390 Euro
	structured varnish lava black	10708	390 Euro
Door lock (per door/piece)	nickel-plated, matt	10035	148 Euro
Shelf for technology housing	structured varnish arctic white	10030	40 Euro
	structured varnish lava black	10670	40 Euro
Cable roll holder on the back side of the mobile version	structured varnish arctic white	10036	140 Euro
	structured varnish lava black	10665	140 Euro

Media column_W8 M²

for 55" to 65" displays
with each up to 60 kg weight

VC camera position:

above display (height variable from 195 cm upward)
or below display (height about 102 cm)

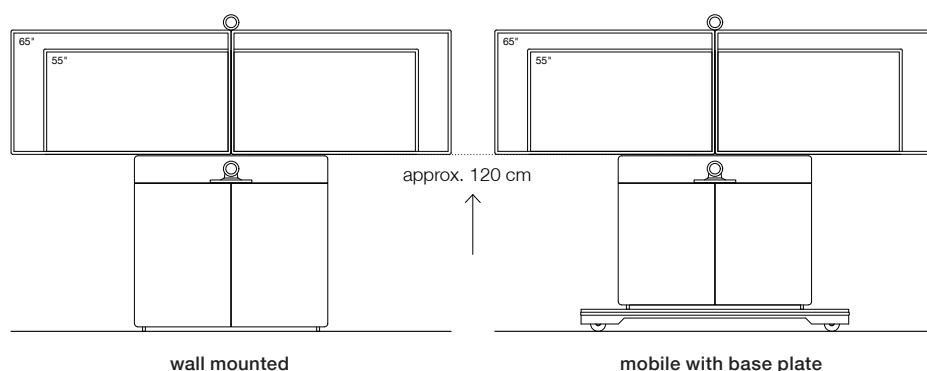

Type / Design

Two doors – with textile cover for external speakers in black.
Body and door made of MDF, finished with structured varnish.
Passive body ventilation for individual technology integration.

Prepared for the integration of a video conference system. Display mount not included.

Dimensions (W x D x H)

Furniture, outside (base plate)	1300 x 280 x 1900 mm	1300 (1800) x 280 (700) x 1900 (150) mm
Technology housing (*fittings not included)	2 x 560 x 240* x 950 mm	2 x 560 x 240* x 820 mm
Speaker housing	1120 x 240 x 165 mm	1120 x 240 x 165 mm

Requirements for display integration

- max. display width	1600 mm	1600 mm
- max. display weight	60 kg	60 kg
- recom. display depth (incl. mount)	80 - 100 mm	80 - 100 mm
- space for display mount (W x H)	2200 x 650 mm	2200 x 650 mm
- recess for display and mount	80 mm	80 mm
- height of the display's lower edge	1200 mm	1200 mm

Color** / Item number

arctic white	10022	10024
lava black	10023	10025

Base price for 1 unit

4.530 Euro

6.260 Euro

excluding transportation

(order of 3 or more = scaled conditions!)

on request

on request

Shipping

on request

Options	Surface / Color	Item number	Sales price
VC camera housing below display with centrally divided speaker cover, dimensions 340 x 240 x 180 mm (W x D x H)	structured varnish arctic white	10672	390 Euro
	structured varnish lava black	10673	390 Euro
VC camera mount - for position above display, space 240 x 150 mm (W x D) - for position in front of speaker cover, space 250 x 200 mm (W x D)	metal, powder coated, black	10033	190 Euro
	metal, powder coated, black	10034	190 Euro
Customized bezel for VC systems / cameras for example for Cisco Webex Room Kit Mini / Logitech Meet up / etc. incl. mounting substructure This bezel replaces the speaker covers of the main product.	structured varnish arctic white	10709	390 Euro
	structured varnish lava black	10710	390 Euro
Door lock (per door/piece)	nickel-plated, matt	10035	148 Euro
Shelf for technology housing	structured varnish arctic white	10031	40 Euro
	structured varnish lava black	10674	40 Euro
Cable roll holder on the back side of the mobile version	structured varnish arctic white	10036	140 Euro
	structured varnish lava black	10665	140 Euro

Media column_W8 L²

for 70" to 80" displays
with each up to 80 kg weight

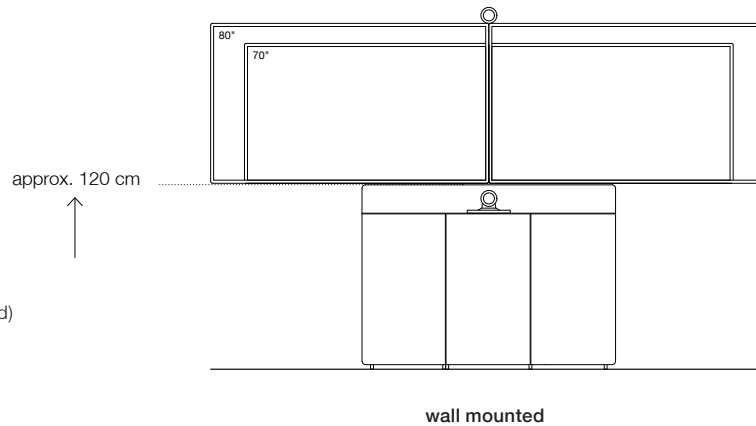

VC camera position:

above display (height variable from 210 cm upward)
or below display (height about 102 cm)

Type / Design

Three doors – with textile cover for external speakers in black.
Body and door made of MDF, finished with structured varnish.
Passive body ventilation for individual technology integration.
Prepared for the integration of a video conference system. Display mount not included.

Dimensions (W x D x H)

Furniture, outside (base plate)	1650 x 310 x 1960 mm
Technology housing (*fittings not included)	2 x 450 x 270* x 950 mm 1 x 520 x 270* x 950 mm
Speaker housing	2 x 430 x 270 x 165 mm

Requirements for display integration

- max. display width	1900 mm
- max. display weight	80 kg
- recom. display depth (incl. mount)	110 - 130 mm
- space for display mount (W x H)	2850 x 710 mm
- recess for display and mount	110 mm
- height of the display's lower edge	1200 mm

Color** / Item number

arctic white	10026
lava black	10027

Base price for 1 unit

excluding transportation	5.940 Euro
(order of 3 or more = scaled conditions!)	on request

Shipping

on request

Options	Surface / Color	Item number	Sales price
VC camera housing below display with centrally divided speaker cover, dimensions 340 x 270 x 180 mm (W x D x H)	structured varnish arctic white	10675	390 Euro
	structured varnish lava black	10676	390 Euro
VC camera mount - for position above display, space 240 x 150 mm (W x D) - for position in front of speaker cover, space 250 x 200 mm (W x D)	metal, powder coated, black	10033	190 Euro
	metal, powder coated, black	10034	190 Euro
Customized bezel for VC systems / cameras for example for Cisco Webex Room Kit Mini / Logitech Meet up / etc. incl. mounting substructure This bezel replaces the speaker covers of the main product.	structured varnish arctic white	10711	390 Euro
	structured varnish lava black	10712	390 Euro
Door lock (per door/piece)	nickel-plated, matt	10035	148 Euro
Shelf for technology housing	structured varnish arctic white	L:10032, M:10682, R:10683	40 Euro
	structured varnish lava black	L:10677, M:10684, R:10685	40 Euro

Media column_W8 L²

for 70" to 80" displays
with each up to 80 kg weight

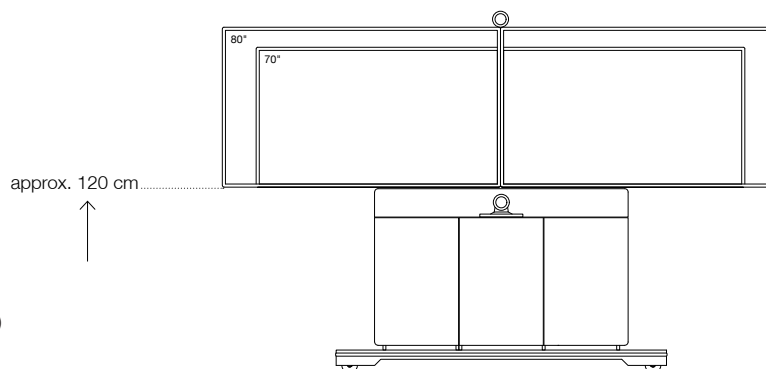

mobile with base plate

Type / Design

Three doors – with textile cover for external speakers in black.
Body and door made of MDF, finished with structured varnish.
Passive body ventilation for individual technology integration.
Prepared for the integration of a video conference system. Display mount not included.

Dimensions (W x D x H)

Furniture, outside (base plate)	1650 (2150) x 310 (700) x 1960 (150) mm
Technology housing (*fittings not included)	2 x 450 x 270* x 820 mm 1 x 520 x 270* x 820 mm
Speaker housing	2 x 430 x 270 x 165 mm

Requirements for display integration

- max. display width	1900 mm
- max. display weight	80 kg
- recom. display depth (incl. mount)	110 - 130 mm
- space for display mount (W x H)	2850 x 710 mm
- recess for display and mount	110 mm
- height of the display's lower edge	1200 mm

Color** / Item number

arctic white	10651
lava black	10652

Base price for 1 unit

excluding transportation	8.270 Euro
(order of 3 or more = scaled conditions!)	on request

Shipping

on request

Options	Surface / Color	Item number	Sales price
VC camera housing below display	structured varnish arctic white	10675	390 Euro
with centrally divided speaker cover, dimensions 340 x 270 x 180 mm (W x D x H)	structured varnish lava black	10676	390 Euro
VC camera mount			
- for position above display, space 240 x 150 mm (W x D)	metal, powder coated, black	10033	190 Euro
- for position in front of speaker cover, space 250 x 200 mm (W x D)	metal, powder coated, black	10034	190 Euro
Customized bezel for VC systems / cameras	structured varnish arctic white	10711	390 Euro
for example for Cisco Webex Room Kit Mini / Logitech Meet up / etc. incl. mounting substructure	structured varnish lava black	10712	390 Euro
This bezel replaces the speaker covers of the main product.			
Door lock (per door/piece)	nickel-plated, matt	10035	148 Euro
Shelf for technology housing	structured varnish arctic white	L:10032, M:10682, R:10683	40 Euro
	structured varnish lava black	L:10677, M:10684, R:10685	40 Euro
Cable roll holder	structured varnish arctic white	10036	140 Euro
on the back side of the mobile version	structured varnish lava black	10665	140 Euro

** Structured varnish colors can be customized on request against surcharge.
Prices = net sales prices, excluding VAT (in Euro)

Media column_W8 XL²

for 84" to 98" displays
with each up to 100 kg weight

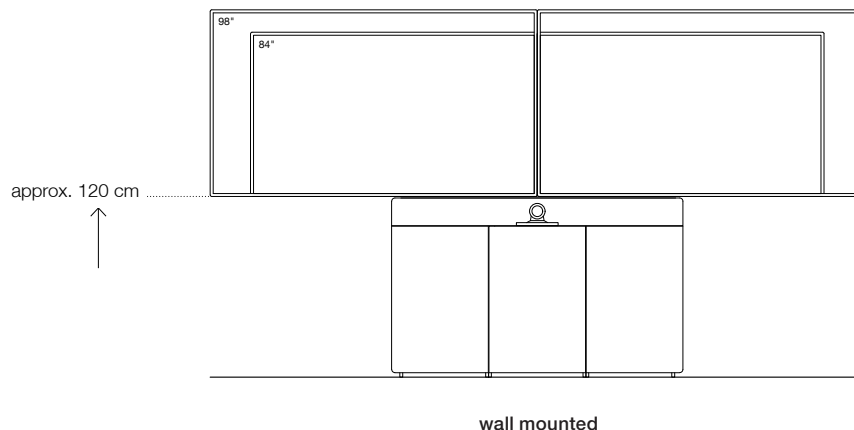

VC camera position:
below display (height about 102 cm)

Type / Design

Three doors – with textile cover for external speakers in black.
Body and door made of MDF, finished with structured varnish.
Passive body ventilation for individual technology integration.
Prepared for the integration of a video conference system. Display mount not included.

Dimensions (W x D x H)

Furniture, outside (base plate)	1950 x 310 x 2070 mm
Technology housing (*fittings not included)	2 x 550 x 270* x 950 mm 1 x 610 x 270* x 950 mm
Speaker housing	2 x 520 x 270 x 165 mm

Requirements for display integration

- max. display width	2280 mm
- max. display weight	100 kg
- recom. display depth (incl. mount)	130 - 150 mm
- space for display mount (W x H)	3400 x 820 mm
- recess for display and mount	130 mm
- height of the display's lower edge	1200 mm

Color** / Item number

arctic white	10653
lava black	10654

Base price for 1 unit

excluding transportation	6.970 Euro
(order of 3 or more = scaled conditions!)	on request

Shipping

on request

Options	Surface / Color	Item number	Sales price
VC camera housing below display with centrally divided speaker cover, dimensions 340 x 270 x 180 mm (W x D x H)	structured varnish arctic white	10679	390 Euro
	structured varnish lava black	10680	390 Euro
VC camera mount for position in front of speaker cover, space 250 x 200 mm (W x D)	metal, powder coated, black	10034	190 Euro
Customized bezel for VC systems / cameras for example for Cisco Webex Room Kit Mini / Logitech Meet up / etc. incl. mounting substructure This bezel replaces the speaker covers of the main product.	structured varnish arctic white	10713	390 Euro
	structured varnish lava black	10714	390 Euro
Door lock (per door/piece)	nickel-plated, matt	10035	148 Euro
Shelf for technology housing	structured varnish arctic white	L+R:10681, M:10686	40 Euro
	structured varnish lava black	L+R:10687, M:10688	40 Euro

Media column_W8 XL²

for 84" to 98" displays
with each up to 100 kg weight

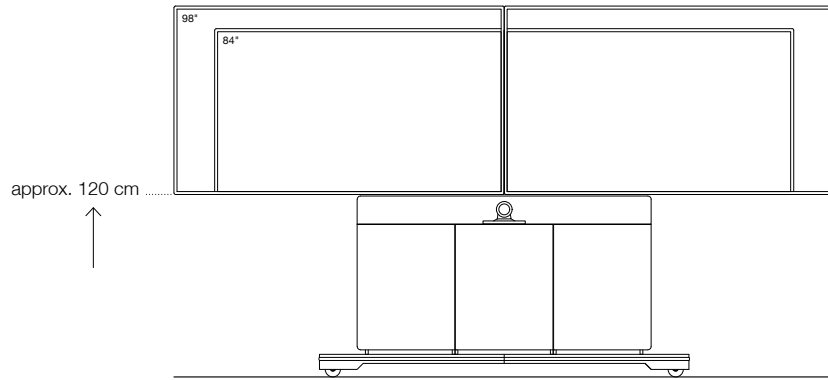

VC camera position:
below display (height about 102 cm)

mobile with base plate

Type / Design

Three doors – with textile cover for external speakers in black.
Body and door made of MDF, finished with structured varnish.
Passive body ventilation for individual technology integration.
Prepared for the integration of a video conference system. Display mount not included.

Dimensions (W x D x H)

Furniture, outside (base plate)	1950 (2450) x 310 (750) x 2070 (150) mm
Technology housing (*fitting not included)	2 x 550 x 270* x 820 mm 1 x 610 x 270* x 820 mm
Speaker housing	2 x 520 x 270 x 165 mm

Requirements for display integration

- max. display width	2280 mm
- max. display weight	100 kg
- recom. display depth (incl. mount)	130 - 150 mm
- space for display mount (W x H)	3400 x 820 mm
- recess for display and mount	130 mm
- height of the display's lower edge	1200 mm

Color / Item number**

arctic white	10655
lava black	10656

Base price for 1 unit

excluding transportation	9.690 Euro
(order of 3 or more = scaled conditions!)	on request

Shipping

on request

Options	Surface / Color	Item number	Sales price
VC camera housing below display with centrally divided speaker cover, dimensions 340 x 270 x 180 mm (W x D x H)	structured varnish arctic white	10679	390 Euro
	structured varnish lava black	10680	390 Euro
VC camera mount for position in front of speaker cover, space 250 x 200 mm (W x D)	metal, powder coated, black	10034	190 Euro
Customized bezel for VC systems / cameras for example for Cisco Webex Room Kit Mini / Logitech Meet up / etc. incl. mounting substructure This bezel replaces the speaker covers of the main product.	structured varnish arctic white	10713	390 Euro
	structured varnish lava black	10714	390 Euro
Door lock (per door/piece)	nickel-plated, matt	10035	148 Euro
Shelf for technology housing	structured varnish arctic white	L+R:10681, M:10686	40 Euro
	structured varnish lava black	L+R:10687, M:10688	40 Euro
Cable roll holder on the back side of the mobile version	structured varnish arctic white	10036	140 Euro
	structured varnish lava black	10665	140 Euro

** Structured varnish colors can be customized on request against surcharge.
Prices = net sales prices, excluding VAT (in Euro)

General elements options

Options	Surface / Color		Item number	Sales price
Custom structured varnish colors according to specification in RAL or NCS color system		single per order	10527	390 Euro
custom cutouts for free positioning of keypads, control panels or connector panels.		1. piece every further, identical		190 Euro 95 Euro
custom drilled holes of up to 68 mm for free positioning of switches, sockets, outlets etc.		1. piece every further, identical	10091 10578	90 Euro 45 Euro
cable passage Ø 60 mm for free positioning, incl. cutouts in body	plastic	1. piece every further, identical	10574 10719	120 Euro 60 Euro
Height and depth customization furniture body can be customized up to - 300 mm in height - 100 mm in depth			10659	10% surcharge on the base item
Custom cabinet adjustment / lateral cutout for placement of VC soundbars without bezel (e.g. for Fohhn Scale Bar and Crestron VC-SB1 in W8 M or L)			10776	10% surcharge
19-inch rack – 4HU for vertical mounting of 19-inch devices in a media column. Easy cable routing and maintenance through integrated mounting and swivel mechanism. (520 x 205 x 195 mm / B x H x T) <u>Attention:</u> For space reasons the use of the rack is not possible in the W8 M and L - as well as in all S1. In the W8 L ² the rack fits only in the center cabinet.	metal, powder coated, black		10442	290 Euro

Replacement bezel plates for media column_W8 new

Replacement bezel plates	Surface / Color**	Sales price
Speaker cover standard spare part as in the main product	acoustic fabric black, back lacquered with structured varnish	
Size M		390 Euro
Size L		490 Euro
Size XL		590 Euro
Size M ²		590 Euro
Size L ²		690 Euro
Size XL ²		790 Euro
Custom speaker cover with custom cutout	acoustic fabric black, back lacquered in structured varnish arctic white or structured varnish lava black	
Size M		590 Euro
Size L		690 Euro
Size XL		790 Euro
Size M ²		790 Euro
Size L ²		890 Euro
Size XL ²		990 Euro
Custom VC bezel plate with cutout and mounting device for VC soundbar	made of MDF in structured varnish arctic white or structured varnish lava black	
Size M		590 Euro
Size L		690 Euro
Size XL		790 Euro
Size M ²		790 Euro
Size L ²		890 Euro
Size XL ²		990 Euro
VC camera housing below display with centrally divided speaker cover	structured varnish arctic white or lava black acoustic fabric black	
Size L		690 Euro
Size XL		790 Euro
Size M ²		790 Euro
Size L ²		890 Euro
Size XL ²		990 Euro

** Structured varnish colors can be customized on request against surcharge.

Prices = net sales prices, excluding VAT (in Euro)