

UC-Display column_W6 - size M

for 50" to 65" displays
with up to 40 kg weight

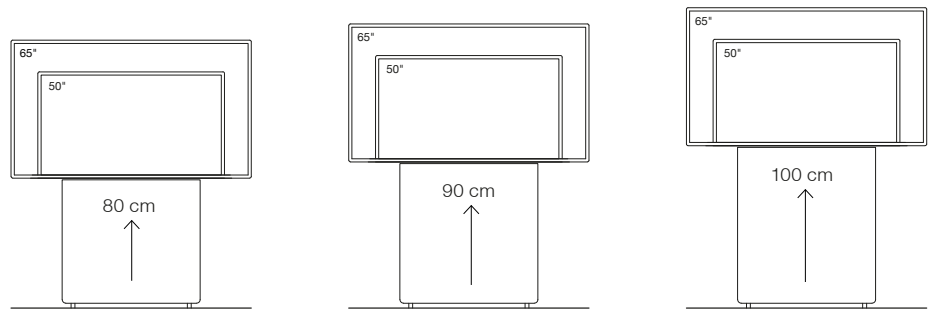

Type / Design

Housing and front cover made of MDF, finished with structured varnish.
For variable height display mounting/-positioning. Display mount not included.

Base furniture with plate height

80 cm

90 cm

100 cm

Dimensions (W x D x H)

Furniture, outside

850 x 150 x 1430 - 1830 mm

850 x 150 x 1430 - 1830 mm

850 x 150 x 1430 - 1830 mm

Technology housing

650 x 115 x 760 mm

650 x 115 x 860 mm

650 x 115 x 960 mm

Requirements for display integration

- max. display width

1600 mm

1600 mm

1600 mm

- max. display weight

40 kg

40 kg

40 kg

- recomm. display depth (incl. mount)

95 - 115 mm

95 - 115 mm

95 - 115 mm

- space for display mount (W x H)

645 x 580 mm

645 x 580 mm

645 x 580 mm

Color / Item number

arctic white = short term, available from stock

basis rate for 1 piece

10072

1.690 Euro

10073

1.740 Euro

10074

1.790 Euro

lava black = order related, with 6 - 8 weeks
delivery time

10579

1.840 Euro

10580

1.890 Euro

10581

1.950 Euro

Base price for 1 unit

excluding transportation

(order of 3 more = scaled conditions!)

on request

on request

on request

Shipping

on request

Options

Surface / Color

Item number

Sales price

Dual-display board M² new

- for 2 x 50" to 65" - displays, dimensions 2200 x 610 mm (W x D)

black MDF, clearly varnished

10767

1.090 Euro

can only be used with wall attachment

VC camera mount

- for position over display, space 240 x 150 mm (W x D)

metal, powder coated, black

10075

210 Euro

- for position below display, in front of corresponding bezel plate M (10909 / 10910),
space 300 x 240 mm (W x D)

metal, powder coated, black

10919

210 Euro

L-Foot

for free positioning on a wall, dimensions 740 x 305 mm (W x D)

metal, powder coated, black

10076

590 Euro

T-Foot

for free positioning in a room, dimensions 740 x 410 mm (W x D)

metal, powder coated, black

10077

690 Euro

+ complementary bezel plates - size M

for the integration of UC-systems / VC-cameras as well as control panels and connector panels

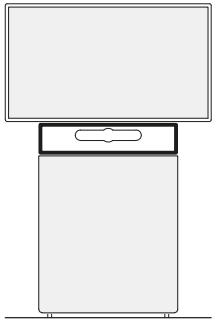

Type / Design

Made of MDF, finished with structured varnish. In width of 85 cm. (In arctic white = short term, available in stock / In lava black = order related, with 6 - 8 weeks delivery time)

Universal,

without cutout*

Height 10 cm

arctic white lava black



Height 20 cm

arctic white lava black



Height 30 cm**

arctic white lava black



Item number

10079 10582

10082 10585

10086 10589

Base price for 1 unit***

160 Euro 175 Euro

210 Euro 230 Euro

260 Euro 285 Euro

Special - in height 20 cm:

... for POLY X30

Set, incl. mounting device

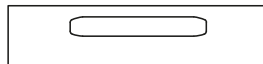

Item number

10730 10735

Base price for 1 unit***

310 Euro 340 Euro

... for POLY STUDIO

Set, incl. mounting device

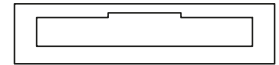

Item number

10729 10734

Base price for 1 unit***

310 Euro 340 Euro

... for Bose VB1

Set, incl. mounting device

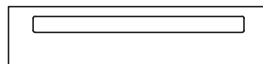

Item number

10733 10738

Base price for 1 unit***

310 Euro 340 Euro

... for AVER VB342

Set, incl. mounting device

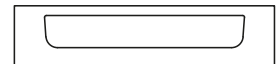

Item number

10895 10899

Base price for 1 unit***

310 Euro 340 Euro

... für Panacast X50 new

Set, incl. mounting device

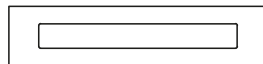

Item number

11215 11216

Base price for 1 unit***

310 Euro 340 Euro

... für Huddly IQ

Incl. mounting bracket / socket



Item number

10845 10846

Base price for 1 unit***

255 Euro 280 Euro

... für Fohhn Hybrid-1 new

Set, incl. mounting device

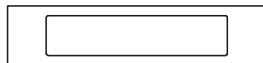

Item number

11170 11171

Base price for 1 unit***

310 Euro 340 Euro

... für Lenovo Think Smart new

tray panel with cable passage

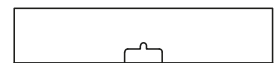

Item number

11211 11212

Base price for 1 unit***

310 Euro 340 Euro

... for mount VC camera

(exclusive mount 10919)

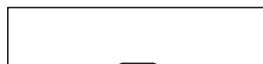

Item number

10909 10910

Base price for 1 unit***

255 Euro 280 Euro

Shipping

on request

* Custom cutouts / drilled holes [from 10 pieces](#) on request possible.

** Can be used in combination with 80 cm and 90 cm high front panel (the height of the lower edge of the display in this case is max. 120 cm).

*** plus transport/delivery | order of 3 or more = scaled conditions

Add-on table_W6 - Size M new in height 74 cm - sitting height

for 50" to 65"- displays with up to 40 kg weight

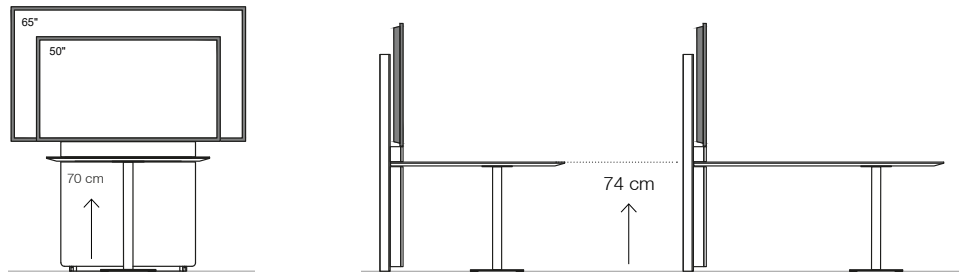

in / to combination
+ Base furniture with plate height 70 cm

Type / Design

Housing and front cover made of MDF, finished with structured varnish.
For variable height display mounting/-positioning. Display mount not included.

Dimensions (W x D x H)

Furniture, outside 850 x 150 x 1430 - 1830
Technology housing 650 x 115 x 660 mm

Requirements for display integration

- max. display width 1600 mm
- max. display weight 40 kg
- recomm. display depth (incl. mount) 95 - 115 mm
- space for display mount (W x H) 645 x 580 mm

Color / Item number

arctic white = short term, available from stock
basis rate for 1 piece

11227
1.640 Euro

lava black = order related, with 6 - 8 weeks delivery time
basis rate for 1 piece

11228
1.790 Euro

excluding transportation
(order of 3 more = scaled conditions!)

on request

on request

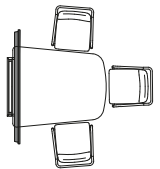
W6 Add-on table 110 for up to 3 people, sitting height	Type / Design Dimension in mm	Color / Surface	Item number	Sales price
	Trapezium shape with rounded edges 1180 x 800 / 1030 x 25 (W x D x H)	Melamin white, chipboard straight edge, for data connection panel with frame	T: 11253	1.490 Euro
	Table leg with base plate, black	Fenix white, table top in MDF chamfered edge, data connection panel frameless possible	T: 11259	2.190 Euro
		Fenix black, table top in MDF chamfered edge, data connection panel frameless possible	T: 11263	2.190 Euro

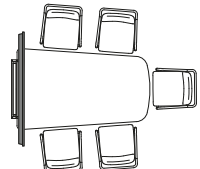
W6 Add-on table 160 for up to 5 people, sitting height	Type / Design Dimension in mm	Color / Surface	Item number	Sales price
	Trapezium shape with rounded edges 1680 x 800 / 1030 x 25 (W x D x H)	Melamin white, chipboard straight edge, for data connection panel with frame	T: 11257	1.790 Euro
	Table leg with base plate, black	Fenix white, table top in MDF chamfered edge, data connection panel frameless possible	T: 11260	2.690 Euro
		Fenix black, table top in MDF chamfered edge, data connection panel frameless possible	T: 11264	2.690 Euro

Shipping on request

Options	Surface / Color	Item number	Sales price
L-Foot for free positioning on a wall, dimensions 740 x 305 mm (W x D)	metal, powder coated, black	10076	590 Euro
T-Foot for free positioning in a room, dimensions 740 x 410 mm (W x D)	metal, powder coated, black	10077	690 Euro

Add-on table_W6 - Size M new in height 105 cm - standing height

for 50" to 65"- displays with up to 40 kg weight

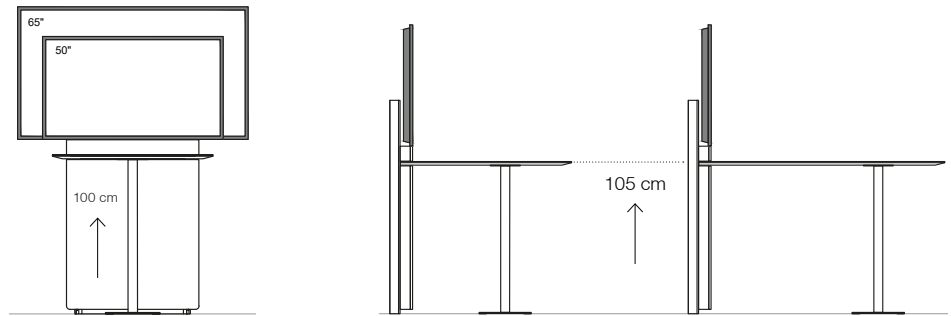

in / to combination
+ Base furniture with plate height 100 cm

Type / Design

Housing and front cover made of MDF, finished with structured varnish.
For variable height display mounting/-positioning. Display mount not included.

Dimensions (W x D x H)

Furniture, outside 850 x 150 x 1430 - 1930
Technology housing 650 x 115 x 960 mm

Requirements for display integration

- max. display width 1600 mm
- max. display weight 40 kg
- recomm. display depth (incl. mount) 95 - 115 mm
- space for display mount (W x H) 645 x 580 mm

Color / Item number

arctic white = short term, available from stock
basis rate for 1 piece

10074
1.790 Euro

lava black = order related, with 6 - 8 weeks delivery time
basis rate for 1 piece

10581
1.950 Euro

excluding transportation
(order of 3 more = scaled conditions!)

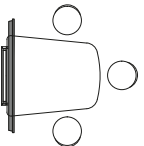
W6 Add-on table 110 for up to 3 people, standing height	Type / Design Dimension in mm	Color / Surface	Item number	Sales price
	Trapezium shape with rounded edges 1180 x 800 / 1030 x 25 (W x D x H) Table leg with base plate, black	Melamin white, chipboard straight edge, for data connection panel with frame	T: 11256	1.540 Euro
		Fenix white, table top in MDF chamfered edge, data connection panel frameless possible	T: 11261	2.240 Euro
		Fenix black, table top in MDF chamfered edge, data connection panel frameless possible	T: 11265	2.240 Euro

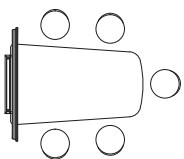
W6 Add-on table 160 for up to 5 people, standing height	Type / Design Dimension in mm	Color / Surface	Item number	Sales price
	Trapezium shape with rounded edges 1680 x 800 / 1030 x 25 (W x D x H) Table leg with base plate, black	Melamin white, chipboard straight edge, for data connection panel with frame	T: 11258	1.840 Euro
		Fenix white, table top in MDF chamfered edge, data connection panel frameless possible	T: 11262	2.740 Euro
		Fenix black, table top in MDF chamfered edge, data connection panel frameless possible	T: 11266	2.740 Euro

Shipping on request

Options	Surface / Color	Item number	Sales price
L-Foot for free positioning on a wall, dimensions 740 x 305 mm (W x D)	metal, powder coated, black	10076	590 Euro
T-Foot for free positioning in a room, dimensions 740 x 410 mm (W x D)	metal, powder coated, black	10077	690 Euro

UC-Display column_W6 - size L

for 70" to 80" displays
with up to 60 kg weight

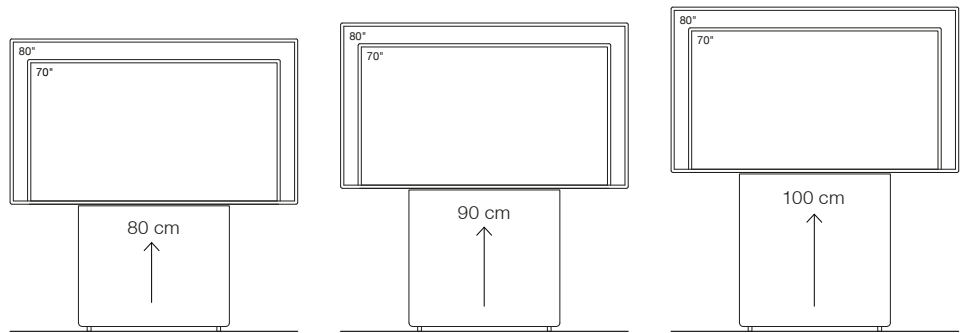

Type / Design

Housing and front cover made of MDF, finished with structured varnish.
For variable height display mounting/-positioning. Display mount not included.

Base furniture with plate height	80 cm	90 cm	100 cm
Dimensions (W x D x H)			
Furniture, outside	950 x 180 x 1650 - 1950 mm	950 x 180 x 1650 - 1950 mm	950 x 180 x 1650 - 1950 mm
Technology housing	750 x 140 x 760 mm	750 x 140 x 860 mm	750 x 140 x 960 mm
Requirements for display integration			
- max. display width	1900 mm	1900 mm	1900 mm
- max. display weight	60 kg	60 kg	60 kg
- recomm. display depth (incl. mount)	120 - 130 mm	120 - 130 mm	120 - 130 mm
- space for display mount (W x H)	745 x 620 mm	745 x 620 mm	745 x 620 mm
Color / Item number			
arctic white = short term, available from stock	10612	10613	10614
basis rate for 1 piece	1.990 Euro	2.060 Euro	2.030 Euro
lava black = order-related, with 6 - 8 weeks delivery time	10620	10621	10622
Base price for 1 unit	2.070 Euro	2.150 Euro	2.220 Euro
excluding transportation (order of 3 more = scaled conditions!)	on request	on request	on request
Shipping	on request		

Options	Surface / Color	Item number	Sales price
Dual-display board L² new - for 2 x 70" to 80" - displays, dimensions 2600 x 670 mm (W x D) can only be used with wall attachment	black MDF, clearly varnished	10866	1.390 Euro
VC camera mount - for position over display, space 240 x 150 mm (W x D) - for position below display, in front of corresponding bezel plate L (10915 / 10916), space 300 x 240 mm (W x D)	metal, powder coated, black	10075	210 Euro
	metal, powder coated, black	10919	210 Euro
L-Foot for free positioning on a wall, dimensions 840 x 335 mm (W x D)	metal, powder coated, black	10616	690 Euro
T-Foot for free positioning in a room, dimensions 840 x 460 mm (W x D)	metal, powder coated, black	10617	840 Euro

+ complementary bezel plates - size L

for the integration of UC-systems / VC-cameras as well as control panels and connector panels

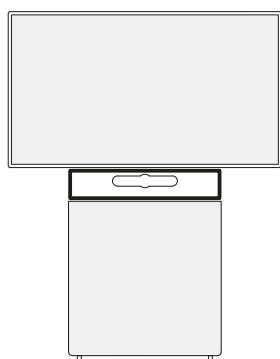

Type / Design

Made of MDF, finished with structured varnish. In width of 85 cm. (In arctic white = short term, available in stock / In lava black = order related, with 6 - 8 weeks delivery time)

Universal,
without cutout**

Height 10 cm
arctic white lava black

Height 20 cm
arctic white lava black

Height 30 cm**
arctic white lava black

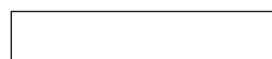
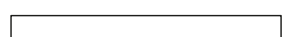

Item number

10623 10634

10626 10637

10630 10641

Base price for 1 unit***

210 Euro 230 Euro

260 Euro 285 Euro

310 Euro 340 Euro

Special - in height 20 cm:

... for POLY STUDIO
Set, incl. mounting device

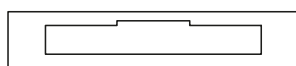

Item number

10859 10860

Base price for 1 unit***

370 Euro 410 Euro

... for POLY X50
Set, incl. mounting device

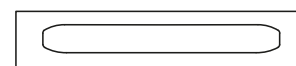

Item number

10731 10736

Base price for 1 unit***

370 Euro 410 Euro

... for AVER VB342
Set, incl. mounting device

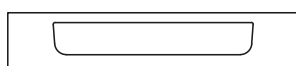

Item number

10897 10901

Base price for 1 unit***

370 Euro 410 Euro

... for Bose VB1
Set, incl. mounting device

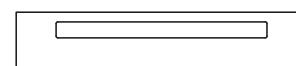

Item number

10922 10923

Base price for 1 unit***

370 Euro 410 Euro

... for Cisco Room Kit
Set, incl. mounting device

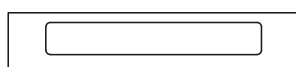

Item number

10904 10905

Base price for 1 unit***

370 Euro 410 Euro

... for Lenovo Think Smart new
tray panel with cable passage



Item number

11213 11214

Base price for 1 unit***

370 Euro 410 Euro

... for Panacast X50 new
Set, incl. mounting device

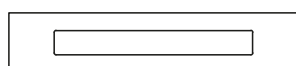

Item number

11217 11218

Base price for 1 unit***

370 Euro 410 Euro

... for Fohhn Hybrid-1 new
Set, incl. mounting device

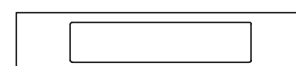

Item number

11172 11173

Base price for 1 unit***

370 Euro 410 Euro

... for mount VC camera
(exclusive mount 10919)

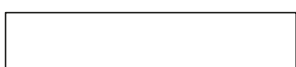

Item number

10915 10916

Base price for 1 unit***

310 Euro 340 Euro

... for Huddly IQ
Incl. mounting bracket / socket



Item number

10855 10856

Base price for 1 unit***

310 Euro 340 Euro

Shipping

on request

* Custom cutouts / drilled holes [from 10 pieces](#) on request possible.

** Can be used in combination with 80 cm and 90 cm high front panel (the height of the lower edge of the display in this case is max. 120 cm).

*** plus transport/delivery | order of 3 or more = scaled conditions