

Holzmedia Smart Furniture

for the perfect synthesis of fine furniture and media technology

Overall program

Price list 2024

including all data, dimensions
and detailed information

valid from 01.11.2023

Holzmedia Elements

Media furniture for the individual integration of displays and media technology

Page



UC-Display column_W6

Size M	10 - 11
Add-on tables - Size M	12 - 13
Size L	14 - 15



Media column_W8

Size M	16
Size L	17
Size XL	18 - 19
Size XXL new	20 - 21
Size M ²	22 - 23
Size L ²	24 - 25
Size XL ²	26 - 27



Media furniture_S1

Size M	29
Size L	30
Size XL	31



LED-Media wall_W9

Size 108" - 110"	32 - 35
Size 130" - 138"	36 - 39
Size 162" - 165" new	40 - 43

General Elements options	44
Replacement bezel plates for Media column_W8	45

Holzmedia Additions

Supplementary furniture that rounds off our performance profile

Page



Lectern_X3

47



Media Cube_X4 **new**

48 - 49

Holzmedia Tables

Table systems for conference and meetings rooms



Conference table_C12

in rectangular / rounded boat shape 52

in trapezium shape 53

in triangular shape 54

in V-shape 55 - 56

options 57

General note / instruction 58

General terms of business 59

Contact 60



Holzmedia
Elements

Media furniture

for the individual integration of
display and media technology

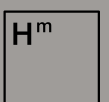

Holzmedia

new Media column_W8 XXL



For 100" bis 110"- displays/LED-panels **also for ultrawide (21:9) screens**

Holzmedia Elements

The perfect product for every requirement

UC-Display colum_W6

all-purpose, standardized modular system □ especially for the integration of VC soundbars □ for height-adjustable positioning of 50"- 80" displays □ wall mounted or freestanding □ a price-oriented solution for small to medium-sized rooms □ in 2 sizes □ sustainably flexible



Media furniture_S1

specialized piece of furniture for the interactive working with touch displays □ height-adjustable by electric motor □ generous storage space for additional technology □ for display sizes from 55"- 98" □ for sophisticated rooms / auditoriums / projects □ can be customized on request, also in color

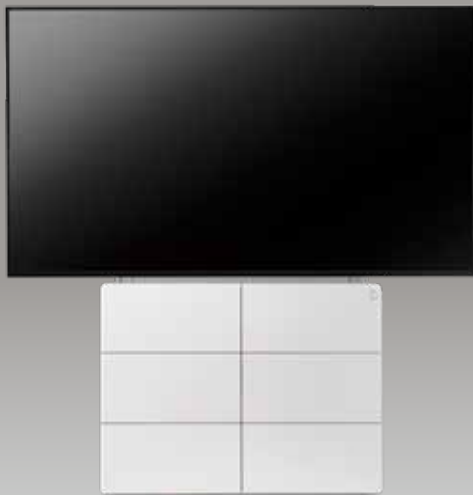

Media column_W8

versatile media column □ perfectly prepared for the integration of professional video conferencing technology □ with generous storage space □ for display sizes from 55"- 110" □ wallfacing or mobile □ for sophisticated rooms / projects □ can be customized on request, also in color



LED-Media wall_W9

concept furniture for large-format LED panels □ perfectly prepared for the integration of professional video conferencing technology as well as powerful speaker systems □ standard version for panel sizes from 108" - 165" □ customizable on request for nearly any size and format – including mobile versions

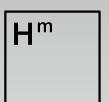

Holzmedia

Holzmedia Elements overview

The perfect product for every requirement

	Display sizes				LED panel sizes (diagonal)			Dual display is possible
	max. display weight							
	M	L	XL	XXL				
	50/55" - 65"	70" - 80"	84" - 98"	100" - 110"	108" - 110"	135" - 138"	162" - 165"	
UC Display column W6	■ 40 kg	■ 60 kg						■ wall mounted with dual display board
Media column W8	■ 60 kg	■ 80 kg	■ 100 kg	■ 120 kg				■ except of XXL
Media furniture S1	■ 60 kg	■ 100 kg	■ 130 kg					□ wall mounted
LED-Media wall W9					■	■	■	□

■ = standard

□ = individual / on request

✗ = not possible

Wall mounted	Mobile with base plate	Freestanding with stand foot	VC integration is possible	Speaker integration is possible	Variable display height/ bottom edge	Standard colors	Individual colors
■	×	■ L- or T-metal foot	■ by means of bezel plates	×	■ 70 -120 cm in increments of 10 cm	W / B W (arctic white) B (lava black)	×
■	■ also dual	□	■ optional	■		W / B	■
■	■			■ optional	■ infinitely variable with electric motor	W / B	■
■	□	□	■ optional	■ optional		W / B	■

UC-Display column_W6 - size M (usually available from stock on short notice!)

for 50" to 65" displays
with up to 40 kg weight

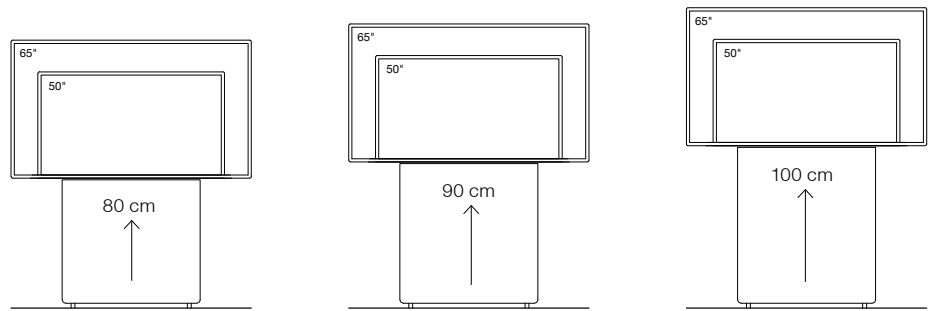

Type / Design

Housing and front cover made of MDF, finished with structured varnish.
For variable height display mounting/-positioning. Display mount not included.

Base furniture with plate height

80 cm

90 cm

100 cm

Dimensions (W x D x H)

Furniture, outside

850 x 150 x 1430 - 1830 mm

850 x 150 x 1430 - 1830 mm

850 x 150 x 1430 - 1830 mm

Technology housing

650 x 115 x 760 mm

650 x 115 x 860 mm

650 x 115 x 960 mm

Requirements for display integration

- max. display width

1600 mm

1600 mm

1600 mm

- max. display weight

40 kg

40 kg

40 kg

- recomm. display depth (incl. mount)

95 - 115 mm

95 - 115 mm

95 - 115 mm

- space for display mount (W x H)

645 x 580 mm

645 x 580 mm

645 x 580 mm

Color / Item number

arctic white

10072

10073

10074

basis rate for 1 piece

1.790 Euro

1.845 Euro

1.895 Euro

lava black

10579

10580

10581

basis rate for 1 piece

1.790 Euro

1.845 Euro

1.895 Euro

excluding transportation

(order of 3 more = scaled conditions!)

on request

on request

on request

Shipping within Europe

Delivery of 1-4 pieces per
pallet (further units = same
price)

12029

390 Euro

Delivery and installation

on request

Options

Surface / Color

Item number

Sales price

Dual display board M²

- for 2 x 50" to 65" displays, dimensions 2200 x 610 mm (W x D)
Can only be used with wall attachment!

black MDF, clearly varnished

10767

1.090 Euro

VC camera mount

- for position over display, space 240 x 165 mm (W x D)
- for position below display, in front of corresponding bezel plate M (10909 / 10910),
space 300 x 240 mm (W x D)

metal, powder coated, black
metal, powder coated, black

10033
10919

220 Euro
220 Euro

L-foot

for free positioning on a wall, dimensions 740 x 305 mm (W x D)

metal, powder coated, black

10076

590 Euro

T-foot

for free positioning in a room, dimensions 740 x 410 mm (W x D)

metal, powder coated, black

10077

690 Euro

+ complementary bezel plates - size M

for the integration of UC-systems / VC-cameras as well as control panels and connector panels

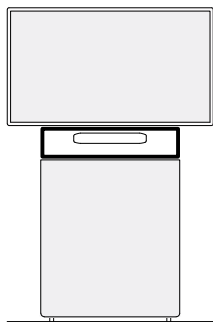

Type / Design

Made of MDF, finished with structured varnish. In width of 85 cm.

Universal,

without cutout*

Height 10 cm

arctic white lava black



Item number

10079 10582

Base price for 1 unit***

170 Euro 170 Euro

Height 20 cm

arctic white lava black

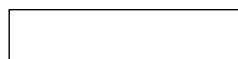

10082 10585

220 Euro 220 Euro

Height 30 cm**

arctic white lava black



10086 10589

275 Euro 275 Euro

Special - in height 20 cm:

... for POLY X30 + R30

Set, incl. mounting device

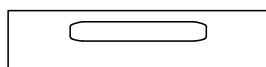

Item number

11955 11957

Base price for 1 unit***

330 Euro 330 Euro

... for POLY STUDIO

Set, incl. mounting device

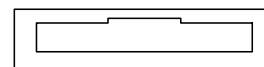

Item number

10729 10734

Base price for 1 unit***

330 Euro 330 Euro

... for Bose VB1

Set, incl. mounting device

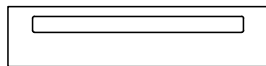

Item number

10733 10738

Base price for 1 unit***

330 Euro 330 Euro

... for AVER VB342+

Set, incl. mounting device

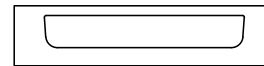

Item number

10895 10899

Base price for 1 unit***

330 Euro 330 Euro

... for Jabra PanaCast 50

Set, incl. mounting device

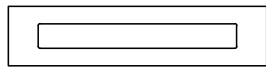

Item number

11215 11216

Base price for 1 unit***

330 Euro 330 Euro

... for Huddly IQ

Incl. mounting bracket/ socket



Item number

10845 10846

Base price for 1 unit***

270 Euro 270 Euro

Universal UC body

for VC bars up to 570 x 115 x 120 mm

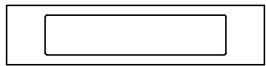

Item number

11397 11398

Base price for 1 unit***

330 Euro 330 Euro

Universal bezel

with tray and cable outlet, for example for Lenovo Think Smart

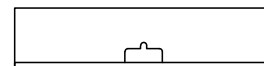

Item number

11211 11212

Base price for 1 unit***

330 Euro 330 Euro

...for mount VC camera

(exclusive mount 10919)



Item number

10909 10910

Base price for 1 unit***

270 Euro 270 Euro

Universal mounting device new without bezel, with depth compensation for systems wider than 85 cm

MDF, black

Item number

10964

Base price for 1 unit***

90 Euro

Shipping within Europe

10092

30 Euro

* Custom cutouts / drilled holes [from 10 pieces](#) on request possible.

** Can be used in combination with 80 cm and 90 cm high front panel (the height of the lower edge of the display in this case is max. 120 cm).

*** plus transport/delivery | order of 3 or more = scaled conditions

Add-on table_W6 - Size M (usually available from stock on short notice!) in height 74 cm - sitting height

for 50" to 65"- displays with up to 40 kg weight

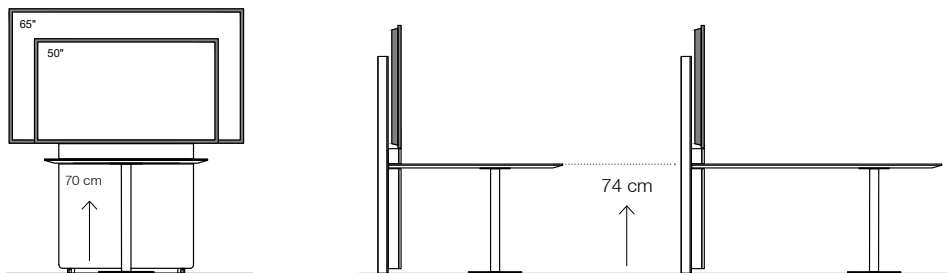

in / to combination
+ Base furniture with plate height 70 cm

Type / Design

Housing and front cover made of MDF, finished with structured varnish.
For variable height display mounting/-positioning. Display mount not included.

Dimensions (W x D x H)

Furniture, outside 850 x 150 x 1430 - 1830
Technology housing 650 x 115 x 660 mm

Requirements for display integration

- max. display width 1600 mm
- max. display weight 40 kg
- recomm. display depth (incl. mount) 95 - 115 mm
- space for display mount (W x H) 645 x 580 mm

Color / Item number

arctic white	11227	lava black	11228
basis rate for 1 piece	1.740 Euro	basis rate for 1 piece	1.740 Euro

excluding transportation
(order of 3 more = scaled conditions!)

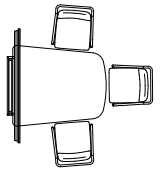
W6 Add-on table 110 for up to 3 people, sitting height	Type / Design Dimension in mm	Color / Surface	Item number	Sales price
	Trapezium shape with rounded edges 1180 x 800 / 1030 x 25 (W x D x H) Table leg with base plate, black	Melamin white, chipboard* straight edge, for data connection panel with frame	T: 11253	1.580 Euro
		Fenix white, table top in MDF chamfered edge, data connection panel frameless possible	T: 11259	2.320 Euro
		Fenix black, table top in MDF chamfered edge, data connection panel frameless possible	T: 11263	2.320 Euro

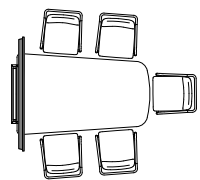
W6 Add-on table 160 for up to 5 people, sitting height	Type / Design Dimension in mm	Color / Surface	Item number	Sales price
	Trapezium shape with rounded edges 1680 x 800 / 1030 x 25 (W x D x H) Table leg with base plate, black	Melamin white, chipboard* straight edge, for data connection panel with frame	T: 11257	1.895 Euro
		Fenix white, table top in MDF chamfered edge, data connection panel frameless possible	T: 11260	2.850 Euro
		Fenix black, table top in MDF chamfered edge, data connection panel frameless possible	T: 11264	2.850 Euro

Shipping within Europe	Delivery of 1-3 pieces per pallet (further units = same price)	11278	390 Euro
-------------------------------	----------------------------------------------------------------	-------	-----------------

Delivery and instalation	on request
---------------------------------	------------

Options	Color / Surface	Item number	Sales price
L-Foot for free positioning on a wall, dimensions 740 x 305 mm (W x D)	metal, powder coated, black	10076	590 Euro
T-Foot for free positioning in a room, dimensions 740 x 410 mm (W x D)	metal, powder coated, black	10077	690 Euro

Add-on table_W6 - Size M (usually available from stock on short notice!) in height 105 cm - standing height

for 50" to 65"- displays with up to 40 kg weight

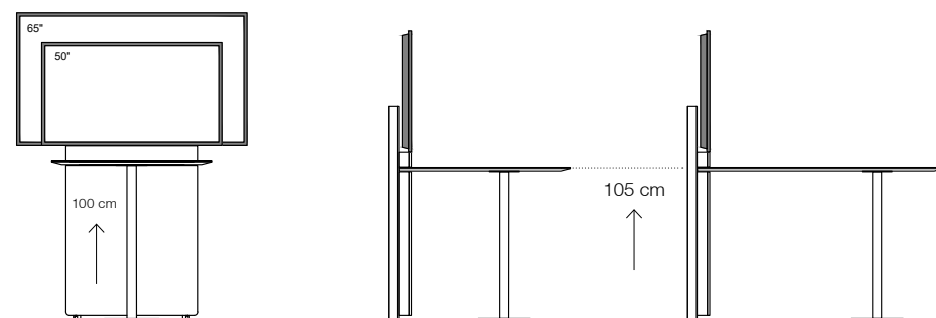

in / to combination
+ Base furniture with plate height 100 cm

Type / Design

Housing and front cover made of MDF, finished with structured varnish.
For variable height display mounting/-positioning. Display mount not included.

Dimensions (W x D x H)

Furniture, outside 850 x 150 x 1430 - 1930
Technology housing 650 x 115 x 960 mm

Requirements for display integration

- max. display width 1600 mm
- max. display weight 40 kg
- recomm. display depth (incl. mount) 95 - 115 mm
- space for display mount (W x H) 645 x 580 mm

Color / Item number

arctic white	10074	lava black	10581
basis rate for 1 piece	1.895 Euro	basis rate for 1 piece	1.895 Euro

excluding transportation
(order of 3 more = scaled conditions!)

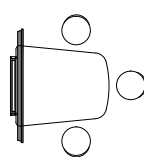
W6 Add-on table 110 for up to 3 people, sitting	Type / Design Dimension in mm	Color / Surface	Item number	Sales price
	Trapezium shape with rounded edges 1180 x 800 / 1030 x 25 (W x D x H) Table leg with base plate, black	Melamin white, chipboard* straight edge, for data connection panel with frame	T: 11256	1.635 Euro
		Fenix white, table top in MDF chamfered edge, data connection panel frameless possible	T: 11261	2.375 Euro
		Fenix black, table top in MDF chamfered edge, data connection panel frameless possible	T: 11265	2.375 Euro

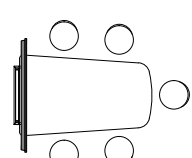
W6 Add-on table 160 for up to 5 people, sitting	Type / Design Dimension in mm	Color / Surface	Item number	Sales price
	Trapezium shape with rounded edges 1680 x 800 / 1030 x 25 (W x D x H) Table leg with base plate, black	Melamin white, chipboard* straight edge, for data connection panel with frame	T: 11258	1.950 Euro
		Fenix white, table top in MDF chamfered edge, data connection panel frameless possible	T: 11262	2.905 Euro
		Fenix black, table top in MDF chamfered edge, data connection panel frameless possible	T: 11266	2.905 Euro

Shipping within Europe	Delivery of 1-3 pieces per pallet (further units = same price)	11278	390 Euro
-------------------------------	----------------------------------------------------------------	-------	-----------------

Delivery and instalation	on request
---------------------------------	------------

Options	Color / Surface	Item number	Sales price
L-Foot for free positioning on a wall, dimensions 740 x 305 mm (W x D)	metal, powder coated, black	10076	590 Euro
T-Foot for free positioning in a room, dimensions 740 x 410 mm (W x D)	metal, powder coated, black	10077	690 Euro

Prices = net sales prices, excluding VAT (in Euro)

*Delivery time for melamin table tops, as well as tabletops with cutouts, is about 8 weeks.

Holzmedia GmbH

UC-Display column_W6 - size L (usually available from stock on short notice!)

for 70" to 80" displays
with up to 60 kg weight

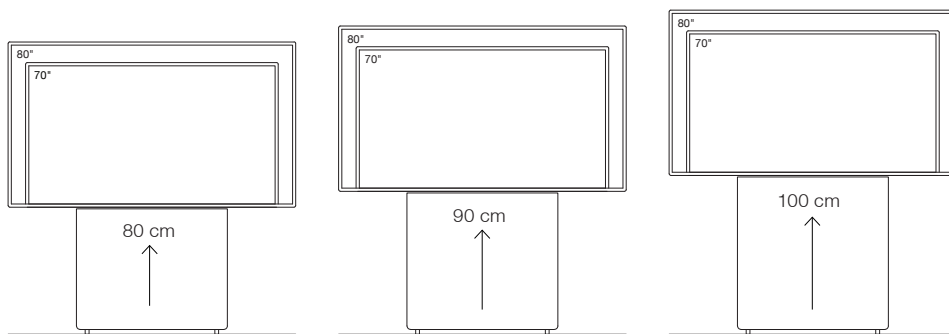

Type / Design

Housing and front cover made of MDF, finished with structured varnish.
For variable height display mounting/-positioning. Display mount not included.

Base furniture with plate height

Dimensions (W x D x H)

	80 cm	90 cm	100 cm
Furniture, outside	950 x 180 x 1650 - 1950 mm	950 x 180 x 1650 - 1950 mm	950 x 180 x 1650 - 1950 mm
Technology housing	750 x 140 x 760 mm	750 x 140 x 860 mm	750 x 140 x 960 mm

Requirements for display integration

	80 cm	90 cm	100 cm
- max. display width	1900 mm	1900 mm	1900 mm
- max. display weight	60 kg	60 kg	60 kg
- recomm. display depth (incl. mount)	120 - 130 mm	120 - 130 mm	120 - 130 mm
- space for display mount (W x H)	745 x 620 mm	745 x 620 mm	745 x 620 mm

Color / Item number

	80 cm	90 cm	100 cm
arctic white	10612	10613	10614
basis rate for 1 piece	2.110 Euro	2.185 Euro	2.260 Euro
lava black	10620	10621	10622
basis rate for 1 piece	2.110 Euro	2.185 Euro	2.260 Euro
excluding transportation (order of 3 more = scaled conditions!)	on request	on request	on request

Shipping within Europe

Delivery of 1-4 pieces per pallet (further units = same price)	12029	390 Euro
----------------------------------------------------------------	-------	-----------------

Delivery and installation

on request

Options

Options	Surface / Color	Item number	Sales price
Dual display board L² - for 2 x 70" to 80" displays, dimensions 2600 x 670 mm (W x D) Can only be used with wall attachment!	black MDF, clearly varnished	10866	1.390 Euro
VC camera mount - for position over display, space 240 x 165 mm (W x D) - for position below display, in front of corresponding bezel plate L (10915 / 10916), space 300 x 240 mm (W x D)	metal, powder coated, black	10033	220 Euro
	metal, powder coated, black	10919	220 Euro
L-Foot for free positioning on a wall, dimensions 840 x 335 mm (W x D)	metal, powder coated, black	10616	690 Euro
T-Foot for free positioning in a room, dimensions 840 x 460 mm (W x D)	metal, powder coated, black	10617	840 Euro

+ complementary bezel plates - size L

for the integration of UC-systems / VC-cameras as well as control panels and connector panels

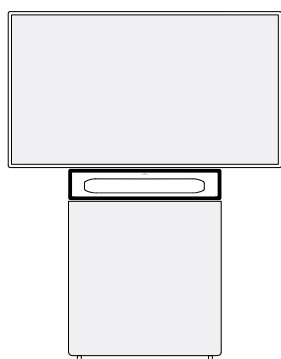

Type / Design

Made of MDF, finished with structured varnish. In width of 95 cm.

Universal,

without cutout*

Height 10 cm

arctic white lava black



Item number

10623 10634

Base price for 1 unit***

220 Euro 220 Euro

Height 20 cm

arctic white lava black

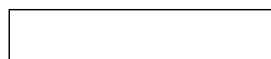

10626 10637

275 Euro 275 Euro

Height 30 cm**

arctic white lava black



10630 10641

330 Euro 330 Euro

Speziell - in Höhe 20 cm:

... for POLY STUDIO

Set, incl. mounting device

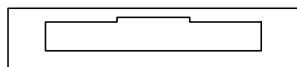

Item number

10859 10860

Base price for 1 unit***

390 Euro 390 Euro

... for POLY X50

Set, incl. mounting device

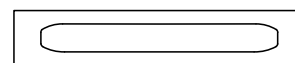

Item number

10731 10736

Base price for 1 unit***

390 Euro 390 Euro

... for Logitech Rally Bar Mini new

Set, incl. mounting device

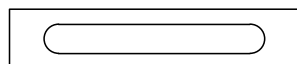

Item number

11316 11317

Base price for 1 unit***

390 Euro 390 Euro

... for Bose VB1

Set, incl. mounting device

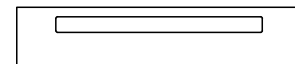

Item number

10922 10923

Base price for 1 unit***

390 Euro 390 Euro

... for Cisco Room Kit

Set, incl. mounting device

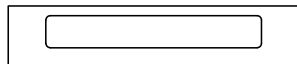

Item number

10904 10905

Base price for 1 unit***

390 Euro 390 Euro

... for Jabra PanaCast 50

Set, incl. mounting device

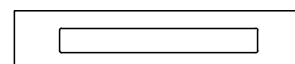

Item number

11217 11218

Base price for 1 unit***

390 Euro 390 Euro

Universal UC body

for VC bars up to 670 x 140 x 120 mm

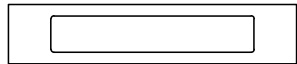

Item number

11399 11400

Base price for 1 unit***

390 Euro 390 Euro

Universal bezel

with tray and cable outlet,
for example for Lenovo Think Smart

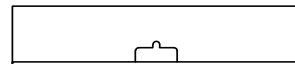

Item number

11213 11214

Base price for 1 unit***

390 Euro 390 Euro

... for mount VC camera

(exclusive mount 10919)



Item number

10915 10916

Base price for 1 unit***

330 Euro 330 Euro

Universal mounting device new
without bezel, with depth compensation
for systems wider than 95 cm

Item number

MDF, black

11405

Base price for 1 unit***

90 Euro

Shipping within Europe

10092

35 Euro

* Custom cutouts / drilled holes [from 10 pieces](#) on request possible.

** Can be used in combination with 80 cm and 90 cm high front panel (the height of the lower edge of the display in this case is max. 120 cm).

*** plus transport/delivery | order of 3 or more = scaled conditions

Media column_W8 M

for 55" to 65" displays
with up to 60 kg weight

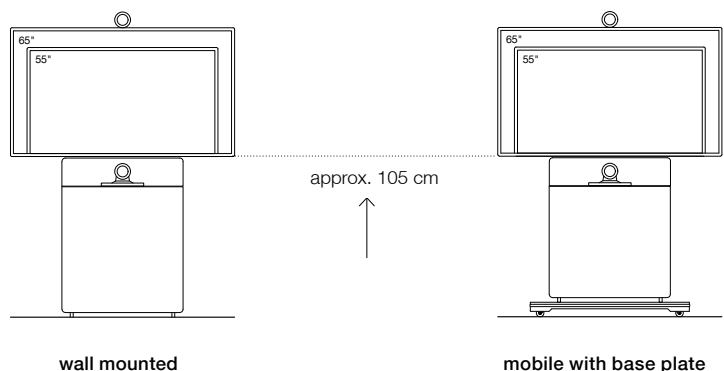

VC camera position:

above display (height variable from 180 cm upward)
or below display (height about 85 cm)

Type / Design

One door – with textile cover for external speakers in black.
Housing and door made of MDF, finished with structured varnish.
Passive housing ventilation for individual technology integration.
Prepared for the integration of a video conference system. Display mount not included.

Dimensions (W x D x H)

Furniture, outside (base plate)	800 x 220 x 1750 mm	800 (1050) x 220 (550) x 1750 (100) mm
Technology housing (*fittings not included)	650 x 180* x 800 mm	650 x 180* x 720 mm
Speaker housing	620 x 180 x 165 mm	620 x 180 x 165 mm

Requirements for display integration

- max. display width	1600 mm	1600 mm
- max. display weight	60 kg	60 kg
- recom. display depth (incl. mount)	80 - 100 mm	80 - 100 mm
- space for display mount (W x H)	700 x 700 mm	700 x 700 mm
- recess for display and mount	80 mm	80 mm
- height of the display's lower edge	1050 mm	1050 mm

Color / Item number**

arctic white	10010	10012
lava black	10011	10013

Base price for 1 unit

3.210 Euro **4.220 Euro**

excluding transportation

(order of 3 or more = scaled conditions!)

on request

on request

Shipping

on request

Options	Surface / Color	Item number	Sales price
VC camera mount			
- for position above display, space 240 x 165 mm (W x D)	metal, powder coated, black	10033	220 Euro
- for position in front and with adapted speaker fabric panel space 250 x 200 mm (W x D)	metal, powder coated, black	10034	440 Euro
Customized bezel for VC systems up to a width of 620 mm			
for Example for Cisco Webex Room Kit Mini / Poly X30/R30 / etc. incl. mounting substructure This bezel replaces the speaker covers of the main product.	structured varnish arctic white	10571	445 Euro
	structured varnish lava black	10704	445 Euro
Door lock (per door/piece)	nickel-plated, matt	10035	170 Euro
Shelf for technology housing	structured varnish arctic white	10028	55 Euro
	structured varnish lava black	10664	55 Euro
Cable roll holder on the back side of the mobile version	structured varnish arctic white	10036	160 Euro
	structured varnish lava black	10665	160 Euro

** Structured varnish colors can be customized on request against surcharge.
Prices = net sales prices, excluding VAT (in Euro)

Media column_W8 L

for 70" to 80" displays
with up to 80 kg weight

VC camera position:

above display (height variable from 210 cm upward)
or below display (height about 102 cm)

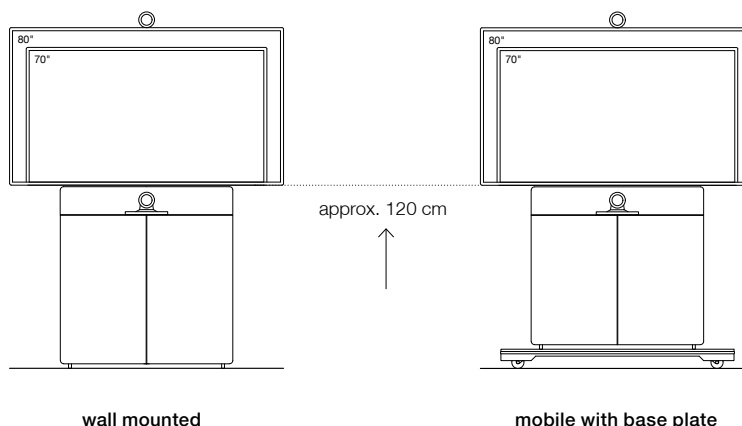

Type / Design

Two doors – with textile cover for external speakers in black.
Housing and door made of MDF, finished with structured varnish.
Passive housing ventilation for individual technology integration.
Prepared for the integration of a video conference system. Display mount not included.

Dimensions (W x D x H)

Furniture, outside (base plate)	1140 x 250 x 1960 mm	1140 (1540) x 250 (650) x 1960 (130) mm
Technology housing (*fittings not included)	2 x 480 x 210* x 950 mm	2 x 480 x 210* x 840 mm
Speaker housing	960 x 210 x 165 mm	960 x 210 x 165 mm

Requirements for display integration

- max. display width	1900 mm	1900 mm
- max. display weight	80 kg	80 kg
- recom. display depth (incl. mount)	110 - 130 mm	110 - 130 mm
- space for display mount (W x H)	1040 x 760 mm	1040 x 760 mm
- recess for display and mount	110 mm	110 mm
- height of the display's lower edge	1200 mm	1200 mm

Color** / Item number

arctic white	10014	10016
lava black	10015	10017

Base price for 1 unit

excluding transportation	3.950 Euro	5.340 Euro
(order of 3 or more = scaled conditions!)	on request	on request

Shipping

on request

Options	Surface / Color	Item number	Sales price
VC camera housing below display***			
with centrally divided speaker cover, dimensions 340 x 210 x 180 mm (W x D x H)	structured varnish arctic white	10667 ***12048	445 Euro
*** = wide version (540 x 210 x 180 mm), for dual cameras	structured varnish lava black	10671 ***12049	445 Euro
VC camera mount	metal, powder coated, black	10033	220 Euro
- for position above display, space 240 x 165 mm (W x D)			
Customized bezel for VC systems up to a width of 960 mm	structured varnish arctic white	10705	445 Euro
for Example for Cisco Webex Room Kit (Plus) / PanaCast 50 / Polycom Studio / etc.	structured varnish lava black	10706	445 Euro
incl. mounting substructure			
This bezel replaces the speaker covers of the main product.			
Door lock (per door/piece)	nickel-plated, matt	10035	170 Euro
Shelf for technology housing	structured varnish arctic white	10029	55 Euro
	structured varnish lava black	10666	55 Euro
Cable roll holder	structured varnish arctic white	10036	160 Euro
on the back side of the mobile version	structured varnish lava black	10665	160 Euro

Media column_W8 XL

for 84" to 98" displays (16:9)
with up to 100 kg weight

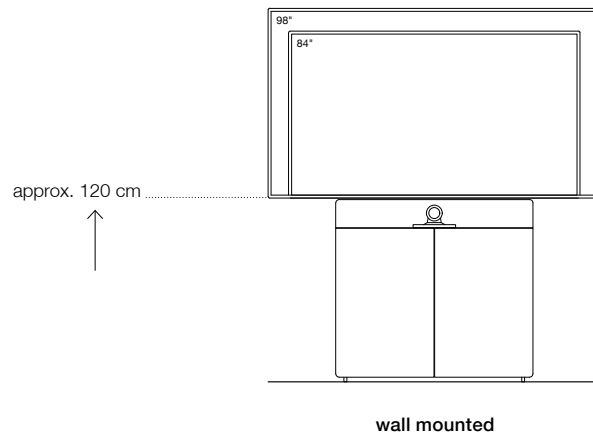

VC camera position:

below display (height about 102 cm)

Type / Design

Two doors – with textile cover for external speakers in black.
Housing and door made of MDF, finished with structured varnish.
Passive housing ventilation for individual technology integration.
Prepared for the integration of a video conference system. Display mount not included.

Dimensions (W x D x H)

Furniture, outside (base plate)	1300 x 280 x 2070 mm
Technology housing (*fittings not included)	2 x 560 x 240* x 950 mm
Speaker housing	1120 x 240 x 165 mm

Requirements for display integration

- max. display width	2280 mm
- max. display weight	100 kg
- recom. display depth (incl. mount)	130 - 150 mm
- space for display mount (W x H)	1200 x 870 mm
- recess for display and mount	130 mm
- height of the display's lower edge	1200 mm

Color** / Item number

arctic white	10018
lava black	10019

Base price for 1 unit

excluding transportation	4.960 Euro
(order of 3 or more = scaled conditions!)	on request

Shipping

on request

Options	Surface / Color	Item number	Sales price
VC camera housing below display**/** with centrally divided speaker cover, dimensions 340 x 210 x 180 mm (W x D x H)	structured varnish arctic white	10668	*10692 ***11441 445 Euro
	structured varnish lava black	10669	*10647 ***11442 445 Euro
* = narrow version (180 x 240 x 180 mm), for Example for Rally Plus *** = wide version (540 x 240 x 180 mm), for dual cameras			
Customized bezel for VC systems up to a width of 1120 mm for Example for Cisco Webex Room Kit (Plus) / Crestron Flex / Polycom Studio / etc. incl. mounting substructure This bezel replaces the speaker covers of the main product.	structured varnish arctic white	10707	445 Euro
	structured varnish lava black	10708	445 Euro
Door lock (per door/piece)	nickel-plated, matt	10035	170 Euro
Shelf for technology housing	structured varnish arctic white	10030	55 Euro
	structured varnish lava black	10670	55 Euro

Media column_W8 XL

for 84" to 98" displays (16:9)
with up to 100 kg weight

approx. 120 cm

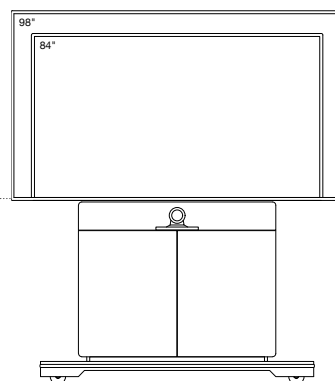

mobile with base plate

VC camera position:

below display (height about 102 cm)

Type / Design

Two doors – with textile cover for external speakers in black.
Housing and door made of MDF, finished with structured varnish.
Passive housing ventilation for individual technology integration.
Prepared for the integration of a video conference system. Display mount not included.

Dimensions (W x D x H)

Furniture, outside (base plate)

1300 (1800) x 280 (700) x 2070 (150) mm

Technology housing (*fittings not included)

2 x 560 x 240* x 820 mm

Speaker housing

1120 x 240 x 165 mm

Requirements for display integration

- max. display width	2280 mm
- max. display weight	100 kg
- recom. display depth (incl. mount)	130 - 150 mm
- space for display mount (W x H)	1200 x 870 mm
- recess for display and mount	130 mm
- height of the display's lower edge	1200 mm

Color** / Item number

arctic white

10020

lava black

10021

Base price for 1 unit

6.965 Euro

excluding transportation

(order of 3 or more = scaled conditions!)

on request

Shipping

on request

Options	Surface / Color	Item number	Sales price
VC camera housing below display**/** with centrally divided speaker cover, dimensions 340 x 210 x 180 mm (W x D x H)	structured varnish arctic white	10668	*10692 ***11441 445 Euro
	structured varnish lava black	10669	*10647 ***11442 445 Euro
* = narrow version (180 x 240 x 180 mm), for Example for Rally Plus *** = wide version (540 x 240 x 180 mm), for dual cameras			
Customized bezel for VC systems up to a width width of 1120 mm for Example for Cisco Webex Room Kit (Plus) / Crestron Flex / Polycom Studio / etc. incl. mounting substructure This bezel replaces the speaker covers of the main product.	structured varnish arctic white	10707	445 Euro
	structured varnish lava black	10708	445 Euro
Door lock (per door/piece)	nickel-plated, matt	10035	170 Euro
Shelf for technology housing	structured varnish arctic white	10030	55 Euro
	structured varnish lava black	10670	55 Euro
Cable roll holder on the back side	structured varnish arctic white	10036	160 Euro
	structured varnish lava black	10665	160 Euro

** Structured varnish colors can be customized on request against surcharge.

Prices = net sales prices, excluding VAT (in Euro)

Holzmedia GmbH

Media column_W8 XXL new

for 100" to 110" displays and LED panels
 also in 21:9 format
 with each up to 120 kg weight

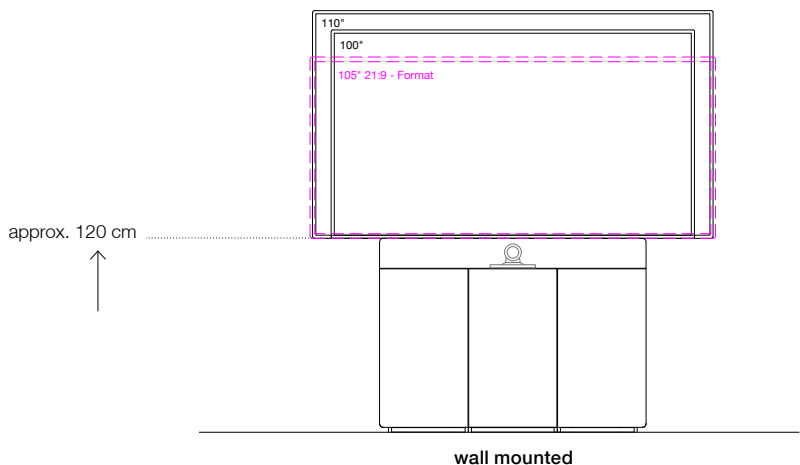

VC camera position:
 below display (height about 102 cm)

Type / Design

Three doors – with textile cover for external speakers in black.
 Housing and door made of MDF, finished with structured varnish.
 Passive housing ventilation for individual technology integration.
 Prepared for the integration of a video conference system. Display mount not included.

Dimensions (W x D x H)

Furniture, outside (base plate)	1650 x 360 x 2210 mm
Technology housing (*fittings not included)	2 x 450 x 320* x 950 mm 1 x 510 x 320* x 950 mm
Speaker housing	2 x 450 x 320 x 165 mm

Requirements for display integration

- max. display width	2440 mm
- max. display weight	120 kg
- recom. display depth (incl. mount)	130 - 150 mm
- space for display mount (W x H)	1550 x 1010 mm
- recess for display and mount	130 mm
- height of the display's lower edge	1200 mm

Color / Item number**

arctic white	11526
lava black	11527

Base price for 1 unit

7.870 Euro

excluding transportation

(order of 3 or more = scaled conditions!)

on request

Shipping

on request

Options	Surface / Color	Item number	Sales price
VC camera housing below display*** with centrally divided speaker cover, dimensions 340 x 270 x 180 mm (W x D x H) *** = wide version (540 x 270 x 180 mm), for dual cameras	structured varnish arctic white	11530 ***11943	445 Euro
	structured varnish lava black	11531 ***11944	445 Euro
Customized bezel for VC systems for Example for Cisco Webex Room Kit (Plus) / Crestron Flex / Polycom Studio / etc. incl. mounting substructure This bezel replaces the speaker covers of the main product.	structured varnish arctic white	11532	445 Euro
	structured varnish lava black	11533	445 Euro
Door lock (per door/piece)	nickel-plated, matt	10035	170 Euro
Shelf for technology housing	structured varnish arctic white	each L/R:11534, M:11535	55 Euro
	structured varnish lava black	each L/R:11536, M:11537	55 Euro
Individual adjustment/enlargement of the display mounting board for LED panels	structured varnish lava black	12033	290 Euro

** Structured varnish colors can be customized on request against surcharge.
 Prices = net sales prices, excluding VAT (in Euro)

Media column_W8 XXL new

for 100" to 110" displays and LED panels
 also in 21:9 format
 with each up to 120 kg weight

approx. 120 cm

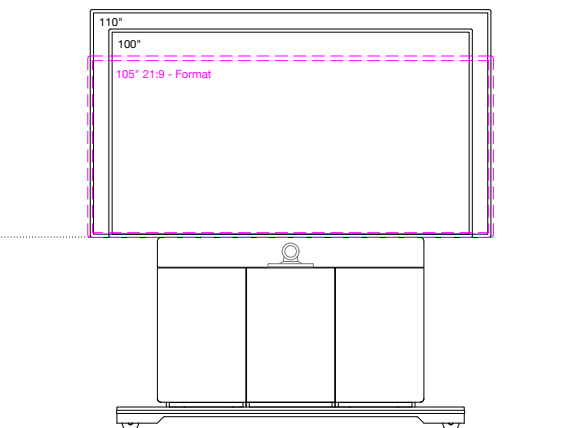

mobile with base plate

VC camera position:

below display (height about 102 cm)

Type / Design

Three doors – with textile cover for external speakers in black.
 Housing and door made of MDF, finished with structured varnish.
 Passive housing ventilation for individual technology integration.
 Prepared for the integration of a video conference system. Display mount not included.

Dimensions (W x D x H)

Furniture, outside (base plate)

1650 (2150) x 360 (750) x 2210 (150) mm

Technology housing (*fittings not included)

2 x 450 x 320* x 820 mm

1 x 510 x 320* x 820 mm

Speaker housing

2 x 450 x 320 x 165 mm

Requirements for display integration

- max. display width

2440 mm

- max. display weight

120 kg

- recom. display depth (incl. mount)

130 - 150 mm

- space for display mount (W x H)

1550 x 1010 mm

- recess for display and mount

130 mm

- height of the display's lower edge

1200 mm

Color** / Item number

arctic white

11528

lava black

11529

Base price for 1 unit

10.880 Euro

excluding transportation

(order of 3 or more = scaled conditions!)

on request

Shipping

on request

Options	Surface / Color	Item number	Sales price
VC camera housing below display***	structured varnish arctic white	11530 ***11943	445 Euro
with centrally divided speaker cover, dimensions 340 x 270 x 180 mm (W x D x H)	structured varnish lava black	11531 ***11944	445 Euro
*** = wide version (540 x 270 x 180 mm), for dual cameras			
Customized bezel for VC systems	structured varnish arctic white	11532	445 Euro
for Example for Cisco Webex Room Kit (Plus) / Crestron Flex / Polycom Studio / etc.	structured varnish lava black	11533	445 Euro
incl. mounting substructure			
This bezel replaces the speaker covers of the main product.			
Door lock (per door/piece)	nickel-plated, matt	10035	170 Euro
Shelf for technology housing	structured varnish arctic white	each L/R:11534, M:11535	55 Euro
	structured varnish lava black	each L/R:11536, M:11537	55 Euro
Individual adjustment/enlargement of the display mounting board for LED panels	structured varnish lava black	12033	290 Euro
Cable roll holder	structured varnish arctic white	10036	160 Euro
on the back side	structured varnish lava black	10665	160 Euro

** Structured varnish colors can be customized on request against surcharge.

Prices = net sales prices, excluding VAT (in Euro)

Holzmedia GmbH

Media column_W8 M²

for 55" to 65" displays
with each up to 60 kg weight

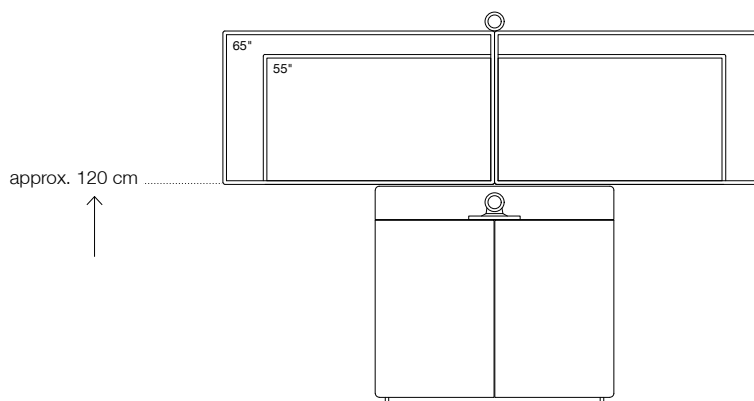

VC camera position:

above display (height variable from 195 cm upward)
or below display (height about 102 cm)

wall mounted

Type / Design

Two doors – with textile cover for external speakers in black.
Housing and door made of MDF, finished with structured varnish.
Passive housing ventilation for individual technology integration.
Prepared for the integration of a video conference system. Display mount not included.

Dimensions (W x D x H)

Furniture, outside (base plate)	1300 x 280 x 1900 mm
Technology housing (*fittings not included)	2 x 560 x 240* x 950 mm
Speaker housing	1120 x 240 x 165 mm

Requirements for display integration

- max. display width	1600 mm
- max. display weight	60 kg
- recom. display depth (incl. mount)	80 - 100 mm
- space for display mount (W x H)	2200 x 650 mm
- recess for display and mount	80 mm
- height of the display's lower edge	1200 mm

Color / Item number**

arctic white	10022
lava black	10023

Base price for 1 unit

excluding transportation	5.290 Euro
(order of 3 or more = scaled conditions!)	on request

Shipping

on request

Options	Surface / Color	Item number	Sales price
VC camera housing below display*/***	structured varnish arctic white	10672 *10678 ***11443	445 Euro
with centrally divided speaker cover, dimensions 340 x 240 x 180 mm (W x D x H)	structured varnish lava black	10673 *10720 ***11444	445 Euro
* = narrow version (180 x 240 x 180 mm), for Example for Rally Plus			
*** = wide version (540 x 240 x 180 mm), for dual cameras			
VC camera mount	metal, powder coated, black	10033	220 Euro
for position in front of speaker cover, space 240 x 165 mm (W x D)			
Customized bezel for VC systems up to a width of 1120 mm	structured varnish arctic white	10709	445 Euro
for Example for Cisco Webex Room Kit (Plus) / Crestron Flex / Polycom Studio / etc.	structured varnish lava black	10710	445 Euro
incl. mounting substructure			
This bezel replaces the speaker covers of the main product.			
Door lock (per door/piece)	nickel-plated, matt	10035	170 Euro
Shelf for technology housing	structured varnish arctic white	10031	55 Euro
	structured varnish lava black	10674	55 Euro

** Structured varnish colors can be customized on request against surcharge.
Prices = net sales prices, excluding VAT (in Euro)

Medienstele_W8 M²

for 55" to 65" displays
with each up to 60 kg weight

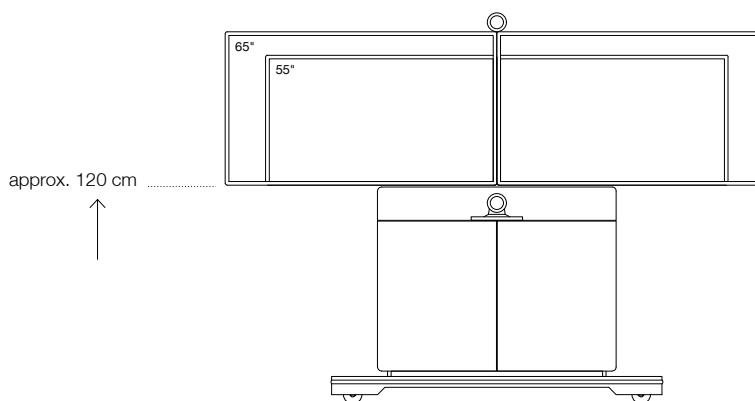

mobile with base plate

Type / Design

Two doors – with textile cover for external speakers in black.
Housing and door made of MDF, finished with structured varnish.
Passive housing ventilation for individual technology integration.
Prepared for the integration of a video conference system. Display mount not included.

Dimensions (W x D x H)

Furniture, outside (base plate)	1300 (1800) x 280 (700) x 1900 (150) mm
Technology housing (*fittings not included)	2 x 560 x 240* x 820 mm
Speaker housing	1120 x 240 x 165 mm

Requirements for display integration

- max. display width	1600 mm
- max. display weight	60 kg
- recom. display depth (incl. mount)	80 - 100 mm
- space for display mount (W x H)	2200 x 650 mm
- recess for display and mount	80 mm
- height of the display's lower edge	1200 mm

Color** / Item number

arctic white	10024
lava black	10025

Base price for 1 unit

excluding transportation	7.295 Euro
(order of 3 or more = scaled conditions!)	on request

Shipping

on request

Options	Surface / Color	Item number	Sales price
VC camera housing below display*/***	structured varnish arctic white	10672 * 10678 *** 11443	445 Euro
with centrally divided speaker cover, dimensions 340 x 240 x 180 mm (W x D x H)	structured varnish lava black	10673 * 10720 *** 11444	445 Euro
* = narrow version (180 x 240 x 180 mm), for Example for Rally Plus			
*** = wide version (540 x 240 x 180 mm), for dual cameras			
VC camera mount			
for position in front of speaker cover, space 240 x 165 mm (W x D)	metal, powder coated, black	10033	220 Euro
Customized bezel for VC systems up to a width of 1120 mm			
for Example for Cisco Webex Room Kit (Plus) / Crestron Flex / Polycom Studio / etc.	structured varnish arctic white	10709	445 Euro
incl. mounting substructure	structured varnish lava black	10710	445 Euro
This bezel replaces the speaker covers of the main product.			
Door lock (per door/piece)	nickel-plated, matt	10035	170 Euro
Shelf for technology housing			
	structured varnish arctic white	10031	55 Euro
	structured varnish lava black	10674	55 Euro
Cable roll holder			
on the back side	structured varnish arctic white	10036	160 Euro
	structured varnish lava black	10665	160 Euro

** Structured varnish colors can be customized on request against surcharge.
Prices = net sales prices, excluding VAT (in Euro)

Holzmedia GmbH

Media column_W8 L²

for 70" to 80" displays
with each up to 80 kg weight

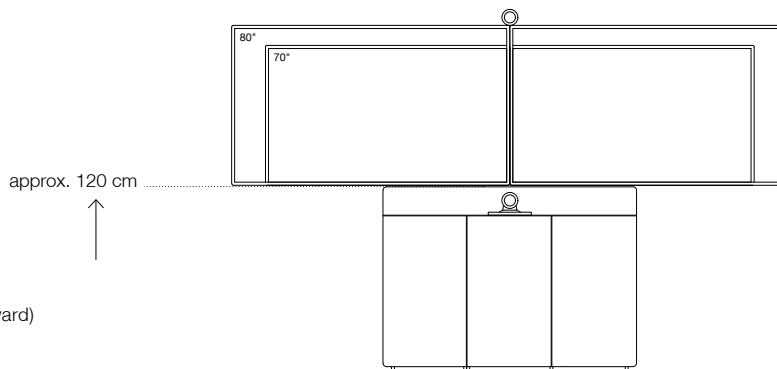

VC camera position:

above display (height variable from 210 cm upward)
or below display (height about 102 cm)

wall mounted

Type / Design

Three doors – with textile cover for external speakers in black.
Housing and door made of MDF, finished with structured varnish.
Passive housing ventilation for individual technology integration.
Prepared for the integration of a video conference system. Display mount not included.

Dimensions (W x D x H)

Furniture, outside (base plate)	1650 x 310 x 1960 mm
Technology housing (*fittings not included)	2 x 440 x 270* x 950 mm 1 x 540 x 270* x 950 mm
Speaker housing	2 x 440 x 270 x 165 mm

Requirements for display integration

- max. display width	1900 mm
- max. display weight	80 kg
- recom. display depth (incl. mount)	110 - 130 mm
- space for display mount (W x H)	2850 x 710 mm
- recess for display and mount	110 mm
- height of the display's lower edge	1200 mm

Color / Item number**

arctic white	10026
lava black	10027

Base price for 1 unit

excluding transportation	6.940 Euro
(order of 3 or more = scaled conditions!)	on request

Shipping

on request

Options	Surface / Color	Item number	Sales price
VC camera housing below display*** with centrally divided speaker cover, dimensions 340 x 270 x 180 mm (W x D x H) *** = wide version (540 x 270 x 180 mm), for dual cameras	structured varnish arctic white	10675 ***11445	445 Euro
	structured varnish lava black	10676 ***11446	445 Euro
VC camera mount for position in front of speaker cover, space 240 x 165 mm (W x D)	metal, powder coated, black	10033	220 Euro
Customized bezel for VC systems for Example for Cisco Webex Room Kit (Plus) / Crestron Flex / Polycom Studio / etc. incl. mounting substructure This bezel replaces the speaker covers of the main product.	structured varnish arctic white	10711	445 Euro
	structured varnish lava black	10712	445 Euro
Door lock (per door/piece)	nickel-plated, matt	10035	170 Euro
Shelf for technology housing	structured varnish arctic white	L:10032, M:10682, R:10683	55 Euro
	structured varnish lava black	L:10677, M:10684, R:10685	55 Euro

** Structured varnish colors can be customized on request against surcharge.
Prices = net sales prices, excluding VAT (in Euro)

Media column_W8 L²

for 70" to 80" displays
with each up to 80 kg weight

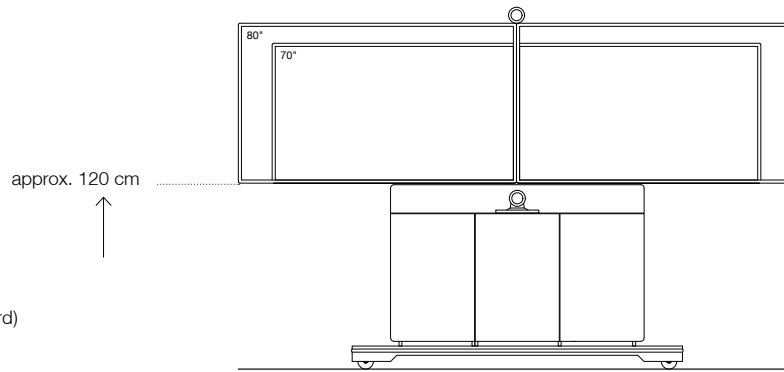

VC camera position:

above display (height variable from 210 cm upward)
or below display (height about 102 cm)

mobile with base plate

Type / Design

Three doors – with textile cover for external speakers in black.
Housing and door made of MDF, finished with structured varnish.
Passive housing ventilation for individual technology integration.
Prepared for the integration of a video conference system. Display mount not included.

Dimensions (W x D x H)

Furniture, outside (base plate)	1650 (2150) x 310 (700) x 1960 (150) mm
Technology housing (*fittings not included)	2 x 440 x 270* x 820 mm 1 x 540 x 270* x 820 mm
Speaker housing	2 x 440 x 270 x 165 mm

Requirements for display integration

- max. display width	1900 mm
- max. display weight	80 kg
- recom. display depth (incl. mount)	110 - 130 mm
- space for display mount (W x H)	2850 x 710 mm
- recess for display and mount	110 mm
- height of the display's lower edge	1200 mm

Color / Item number**

arctic white	10651
lava black	10652

Base price for 1 unit

excluding transportation	9.670 Euro
(order of 3 or more = scaled conditions!)	on request

Shipping

on request

Options	Surface / Color	Item number	Sales price
VC camera housing below display*** with centrally divided speaker cover, dimensions 340 x 270 x 180 mm (W x D x H) *** = wide version (540 x 270 x 180 mm), for dual cameras	structured varnish arctic white	10675 ***11445	445 Euro
	structured varnish lava black	10676 ***11446	445 Euro
VC camera mount for position in front of speaker cover, space 240 x 165 mm (W x D)	metal, powder coated, black	10033	220 Euro
Customized bezel for VC systems for Example for Cisco Webex Room Kit (Plus) / Crestron Flex / Polycom Studio / etc. incl. mounting substructure This bezel replaces the speaker covers of the main product.	structured varnish arctic white	10711	445 Euro
	structured varnish lava black	10712	445 Euro
Door lock (per door/piece)	nickel-plated, matt	10035	170 Euro
Shelf for technology housing	structured varnish arctic white	L:10032, M:10682, R:10683	55 Euro
	structured varnish lava black	L:10677, M:10684, R:10685	55 Euro
Cable roll holder on the back side	structured varnish arctic white	10036	160 Euro
	structured varnish lava black	10665	160 Euro

** Structured varnish colors can be customized on request against surcharge.
Prices = net sales prices, excluding VAT (in Euro)

Media column_W8 XL²

for 84" to 98" displays (16:9)
with each up to 100 kg weight

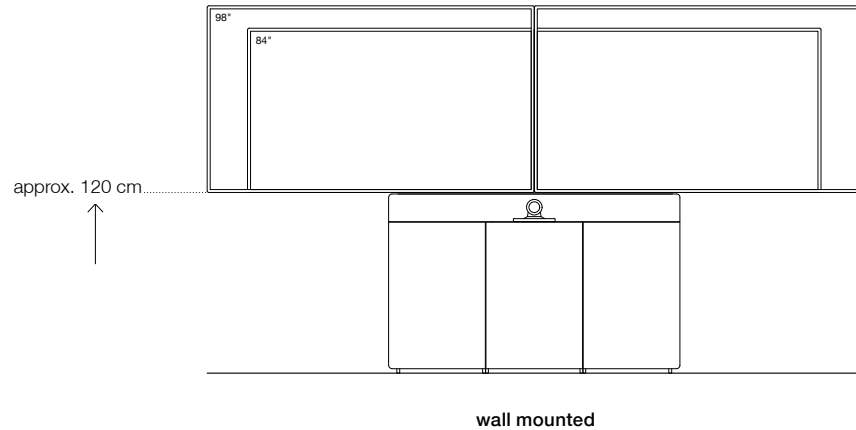

VC camera position:

below display (height about 102 cm)

Type / Design

Three doors – with textile cover for external speakers in black.
Housing and door made of MDF, finished with structured varnish.
Passive housing ventilation for individual technology integration.
Prepared for the integration of a video conference system. Display mount not included.

Dimensions (W x D x H)

Furniture, outside (base plate)	1950 x 310 x 2070 mm
Technology housing (*fittings not included)	2 x 550 x 270* x 950 mm 1 x 610 x 270* x 950 mm
Speaker housing	2 x 520 x 270 x 165 mm

Requirements for display integration

- max. display width	2280 mm
- max. display weight	100 kg
- recom. display depth (incl. mount)	130 - 150 mm
- space for display mount (W x H)	3400 x 820 mm
- recess for display and mount	130 mm
- height of the display's lower edge	1200 mm

Color** / Item number

arctic white	10653
lava black	10654

Base price for 1 unit

excluding transportation	8.150 Euro
(order of 3 or more = scaled conditions!)	on request

Shipping

on request

Options	Surface / Color	Item number	Sales price
VC camera housing below display*** with centrally divided speaker cover, dimensions 340 x 270 x 180 mm (W x D x H) *** = wide version (540 x 270 x 180 mm), for dual cameras	structured varnish arctic white	10679 ***11447	445 Euro
	structured varnish lava black	10680 ***11448	445 Euro
Customized bezel for VC systems for Example for Cisco Webex Room Kit (Plus) / Crestron Flex / Polycom Studio / etc. incl. mounting substructure This bezel replaces the speaker covers of the main product.	structured varnish arctic white	10713	445 Euro
	structured varnish lava black	10714	445 Euro
Door lock (per door/piece)	nickel-plated, matt	10035	170 Euro
Shelf for technology housing	structured varnish arctic white	L/R:10681, M:10686	55 Euro
	structured varnish lava black	L/R:10687, M:10688	55 Euro

Media column_W8 XL²

for 84" to 98" displays (16:9)
with each up to 100 kg weight

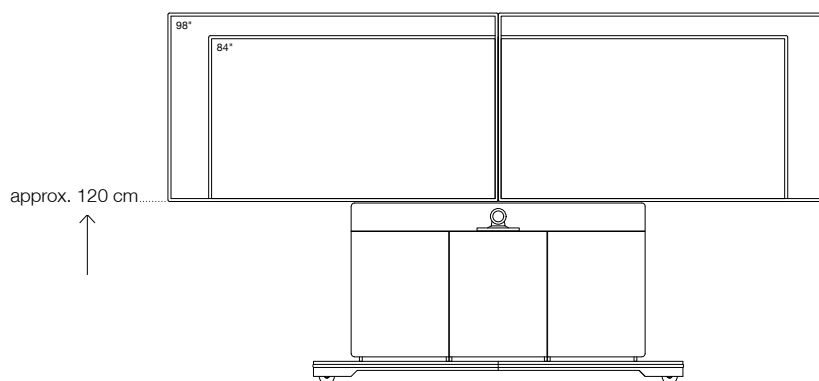

mobile with base plate

VC camera position:
below display (height about 102 cm)

Type / Design

Three doors – with textile cover for external speakers in black.
Housing and door made of MDF, finished with structured varnish.
Passive housing ventilation for individual technology integration.
Prepared for the integration of a video conference system. Display mount not included.

Dimensions (W x D x H)

Furniture, outside (base plate)

1950 (2450) x 310 (750) x 2070 (150) mm

Technology housing (*fittings not included)

2 x 550 x 270* x 820 mm

1 x 610 x 270* x 820 mm

Speaker housing

2 x 520 x 270 x 165 mm

Requirements for display integration

- max. display width	2280 mm
- max. display weight	100 kg
- recom. display depth (incl. mount)	130 - 150 mm
- space for display mount (W x H)	3400 x 820 mm
- recess for display and mount	130 mm
- height of the display's lower edge	1200 mm

Color** / Item number

arctic white	10655
lava black	10656

Base price for 1 unit

11.090 Euro

excluding transportation

(order of 3 or more = scaled conditions!)

on request

Shipping

on request

Options	Surface / Color	Item number	Sales price
VC camera housing below display*** with centrally divided speaker cover, dimensions 340 x 270 x 180 mm (W x D x H) *** = wide version (540 x 270 x 180 mm), for dual cameras	structured varnish arctic white	10679 ***11447	445 Euro
	structured varnish lava black	10680 ***11448	445 Euro
Customized bezel for VC systems for Example for Cisco Webex Room Kit (Plus) / Crestron Flex / Polycom Studio / etc. incl. mounting substructure This bezel replaces the speaker covers of the main product.	structured varnish arctic white	10713	445 Euro
	structured varnish lava black	10714	445 Euro
Door lock (per door/piece)	nickel-plated, matt	10035	170 Euro
Shelf for technology housing	structured varnish arctic white	L/R:10681, M:10686	55 Euro
	structured varnish lava black	L/R:10687, M:10688	55 Euro
Cable roll holder on the back side	structured varnish arctic white	10036	160 Euro
	structured varnish lava black	10665	160 Euro

Media furniture_S1 M

height adjustable
for 55" to 65" displays
with up to 60 kg weight

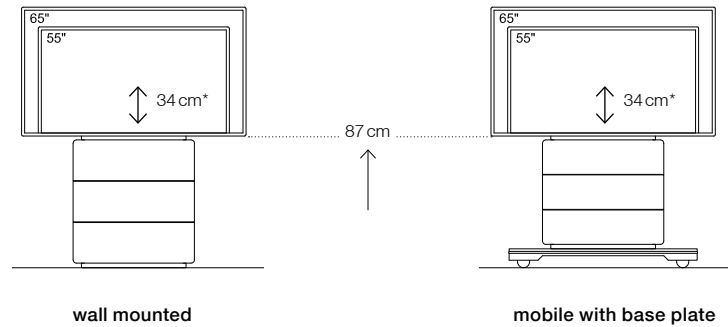

Type / Design

One door - housing and door made of MDF, finished with structured varnish.
Passive housing ventilation for individual technology integration.
Display mount not included.

Dimensions (W x D x H)

Furniture, outside (base plate)	800 x 310 x 1630 mm	800 (1240) x 310 (650) x 1630 (130) mm
Technology housing (fittings not included)	650 x 170/270 x 750 mm	650 x 170/270 x 650 mm
Space for technical components (W x H)	2 x 255 x 750 mm	2 x 255 x 650 mm

Requirements for display integration

- max. display width	1650 mm	1650 mm
- max. display weight	60 kg	60 kg
- recomm. display depth (incl. mount)	110 - 150 mm	110 - 150 mm
- space for display mount (W x H)	620 x 650 mm	620 x 650 mm
- recess for display and mount	110 mm	110 mm
- minimum display height	740 mm	740 mm

Color* / Item number

arctic white	10043	10045
lava black	10044	10046

Base price for 1 unit

5.260 Euro **6.610 Euro**

excluding transportation

(order of 3 or more = scaled conditions!)

on request

on request

Shipping

on request

Options	Surface / Color	Item number	Sales price
VC camera mount			
- for position above display, space 240 x 165 mm (W x D)	metal, powder coated, black	10033	220 Euro
- for position on the side of display for 55" to 98" adjustable, space 240 x 150 mm (W x D)	metal, powder coated, black	10657	445 Euro
Installation adapter plate			
for Cisco Webex Board 55"	structured varnish arctic white	11422	200 Euro
	structured varnish lava black	11421	200 Euro
Door lock (per door/piece)	nickel-plated, matt	10063	170 Euro
Shelf for technology housing			
	structured varnish arctic white	10055	55 Euro
	structured varnish lava black	10689	55 Euro
Door with textile speaker cover			
for external speakers, incl. shelf	structured varnish arctic white, fabric black	10058	530 Euro
	structured varnish lava black, fabric black	10690	530 Euro
Cable roll holder			
on the back side of the mobile version	structured varnish arctic white	12034	160 Euro
	structured varnish lava black	12035	160 Euro

Media furniture_S1 L

height adjustable
for 70" to 80" displays
with up to 100 kg weight

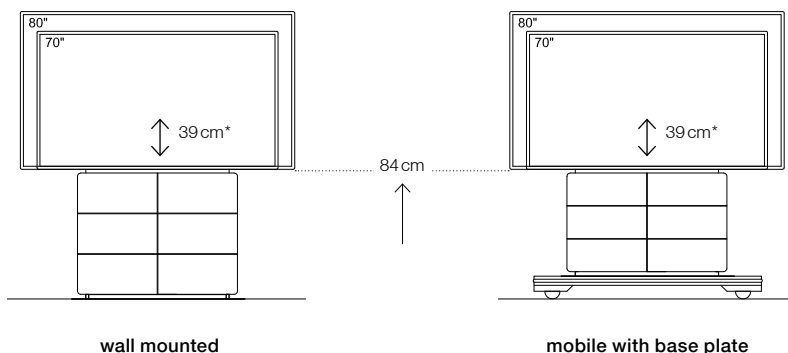

Type / Design

Two doors - housing and door made of MDF, finished with structured varnish.
Passive housing ventilation for individual technology integration.
Display mount not included.

Dimensions (W x D x H)

Furniture, outside (base plate)	1060 x 320 x 1740 mm	1060 (1500) x 320 (700) x 1740 (150) mm
Technology housing (fittings not included)	2 x 440 x 180/280 x 745 mm	2 x 440 x 180/280 x 610 mm
Space for technical components (W x H)	465 x 745 mm	465 x 610

Requirements for display integration

- max. display width	1900 mm	1900 mm
- max. display weight	100 kg	100 kg
- recomm. display depth (incl. mount)	120 - 160 mm	120 - 160 mm
- space for display mount (W x H)	870 x 700 mm	870 x 700 mm
- recess for display and mount	120 mm	120 mm
- minimum display height	900 mm	900 mm

Color* / Item number

arctic white	10047	10049
lava black	10048	10050

Base price for 1 unit

excluding transportation	6.420 Euro	8.150 Euro
(order of 3 or more = scaled conditions!)	on request	on request

Shipping

on request

Options	Surface / Color	Item number	Sales price
VC camera mount			
- for position above display, space 240 x 165 mm (W x D)	metal, powder coated, black	10033	220 Euro
- for position on the side of display for 55" to 98" adjustable, space 240 x 150 mm (W x D)	metal, powder coated, black	10657	445 Euro
Installation adapter plate			
for Cisco Webex Board Pro 75"	structured varnish arctic white	11420	255 Euro
	structured varnish lava black	11419	255 Euro
Door lock (per door/piece)	nickel-plated, matt	10063	160 Euro
Shelf for technology housing			
	structured varnish arctic white	10056	55 Euro
	structured varnish lava black	10694	55 Euro
Door with textile speaker cover			
for external speakers, incl. shelf	structured varnish arctic white, fabric black	10059	590 Euro
	structured varnish lava black, fabric black	10695	590 Euro
Cable roll holder			
on the back side of the mobile version	structured varnish arctic white	12034	160 Euro
	structured varnish lava black	12035	160 Euro

Media furniture_S1 XL

height adjustable
for 84" to 98" displays
with up to 130 kg weight

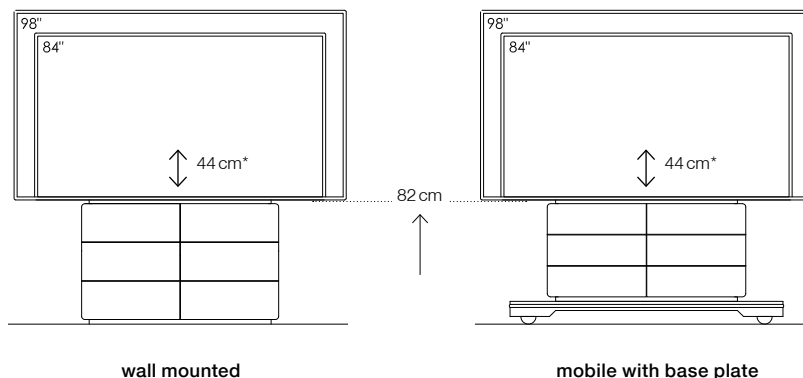

Type / Design

Two doors - housing and door made of MDF, finished with structured varnish.
Passive housing ventilation for individual technology integration.
Display mount not included.

Dimensions (W x D x H)

Furniture, outside (base plate)

1310 x 330 x 1800 mm

1310 (1800) x 330 (750) x 1800 (150) mm

Technology housing (fittings not included)

2 x 570 x 190/290 x 710 mm

2 x 570 x 190/290 x 580 mm

Space for technical components (W x H)

720 x 710 mm

720 x 580 mm

Requirements for display integration

- max. display width

2210 mm

2210 mm

- max. display weight

130 kg

130 kg

- recomm. display depth (incl. mount)

130 - 180 mm

130 - 180 mm

- space for display mount (W x H)

1060 x 690 mm

1060 x 690 mm

- recess for display and mount

130 mm

130 mm

- minimum display height

970 mm

970 mm

Color* / Item number

arctic white

10051

10053

lava black

10052

10054

Base price for 1 unit

7.290 Euro

9.280 Euro

excluding transportation

(order of 3 or more = scaled conditions!)

on request

on request

Shipping

on request

Options	Surface / Color	Item number	Sales price
VC camera mount			
- for position above display, space 240 x 165 mm (W x D)	metal, powder coated, black	10033	220 Euro
- for position on the side of display for 55" to 98" adjustable, space 240 x 150 mm (W x D)	metal, powder coated, black	10657	445 Euro
Door lock (per door/piece)	nickel-plated, matt	10063	170 Euro
Shelf for technology housing	structured varnish arctic white	10057	55 Euro
	structured varnish lava black	10697	55 Euro
Door with textile speaker cover	structured varnish arctic white, fabric black	10060	720 Euro
for external speakers, incl. shelf	structured varnish lava black, fabric black	10698	720 Euro
Cable roll holder	structured varnish arctic white	12034	160 Euro
on the back side of the mobile version	structured varnish lava black	12035	160 Euro

LED-Media wall_W9 - for 108" - 110" (16:9)

without side speaker cabinets

Base module

can not be upgraded

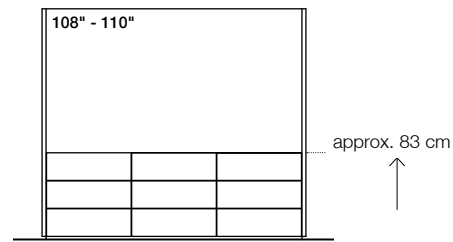

wall mounted, 3-door

Type / Design

Melamine housing, MDF doors and sides, finished with structured varnish.
With passive housing ventilation for individual technology integration.
Prepared for the integration of LED screens.
LED mount not included.

approx. Dimensions (W x D x H)

= individually adapted to LED screen

Furniture, outside

2530 x 320 x 2200 mm

Technology housing (*fittings not included)

3 x 770 x 280 x 740 mm

Mounting surface for LED screens (W x H)

2450 x 1380 mm

Max. screen weight

180 kg

Color** / Item number

arctic white

11961

lava black

11962

Base price for 1 unit

8.120 Euro

excluding transportation

(order of 3 more = scaled conditions!)



Shipping

on request

Options	Surface / Color	Item number	Sales price
Outer doors with speaker panels in fabric for external loud speaker includes shelf space for speakers approx. 730 x 220 mm (W x H) The technology compartments reduces accordingly.	structured varnish arctic white, fabric black	11963	890 Euro
	structured varnish lava black, fabric black	11964	890 Euro
Door lock (per door/piece)	nickel-plated, matt	12036	170 Euro
Shelf for technology housing	structured varnish arctic white	11966	55 Euro
	structured varnish lava black	11967	55 Euro
VC camera mount for lateral positioning on LED-Media wall W9 space: 240 x 150 mm (W x D)	metal, powder coated, black	11968	445 Euro

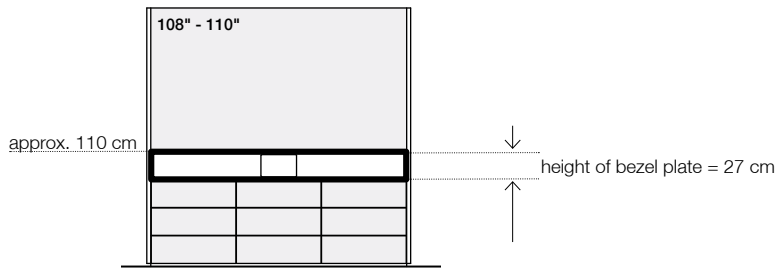
... optionally with bezel plate for VC integration

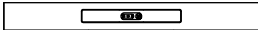

	Approx. size	Surface / Color	Item number	Sales price
Technology cabinet / bezel plate with VC camera				
VC camera cabinet approx: 340 x 210 mm (W x H), below the LED screens				
	108" - 110"	in structured varnish arctic white	11969	1.950 Euro
		in structured varnish lava black	11970	1.950 Euro
Technology cabinet / bezel plate with VC camera, outside with fabric covers for external loud speaker				
(each 730 x 220 mm / W x H)				
	108" - 110"	in structured varnish arctic white	11971	2.175 Euro
		in structured varnish lava black	11972	2.175 Euro
Technology cabinet with custom cutout for VC soundbar				
for the integration of VC bars such as Cisco Webex Room Kit (Plus) / Crestron Flex / Polycom Studio / etc. incl. mounting device				
	108" - 110"	in structured varnish arctic white	11973	2.175 Euro
		in structured varnish lava black	11974	2.175 Euro

LED-Media wall_W9 - for 108" - 110" (16:9)

with lateral speaker cabinets

Base module

for line speaker cabinets and subwoofer

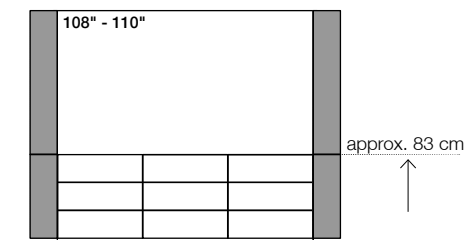

wall mounted, 3-door

Type / Design Melamine housing, MDF doors and sides, finished with structured varnish. Lateral speaker cabinets covered with black fabric completely. With passive housing ventilation for individual technology integration. Prepared for the integration of LED screens. LED mount not included.

approx. Dimensions (W x D x H)

= individually adapted to LED screen

Furniture, outside	2970 x 320 x 2200 mm
Technology housing (*fittings not included)	3 x 770 x 280 x 740 mm
Mounting surface for LED screens (W x H)	2450 x 1380 mm
Speaker housing:	
- above / line speaker cabinet	180 x 240 x 1280 mm
- below / subwoofer	1000 x 250 x 520 mm

Max. screen weight 180 kg

Color / Item number**

arctic white	11975
lava black	11976

Base price for 1 unit 11.630 Euro

excluding transportation
(order of 3 more = scaled conditions!)

Shipping on request

Options	Surface / Color	Item number	Sales price
Door lock (per door/piece)	nickel-plated, matt	12036	170 Euro
Shelf for technology housing	structured varnish arctic white	11966	55 Euro
	structured varnish lava black	11967	55 Euro

** Structured varnish colors can be customized on request against surcharge.
Prices = net sales prices, excluding VAT (in Euro)

... optionally with bezel plate for VC integration

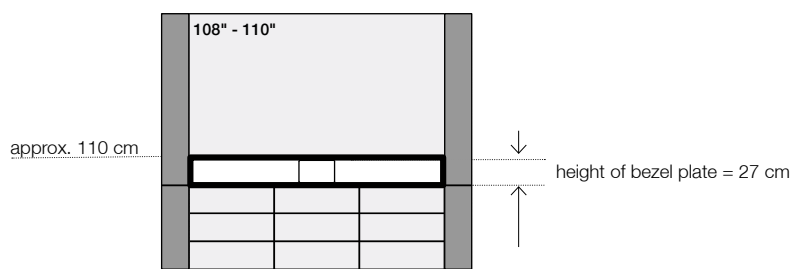

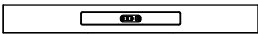
	Approx. size	Surface / Color	Item number	Sales price
Technology cabinet / bezel plate with VC camera				
VC camera cabinet approx: 340 x 210 mm (W x H), below the LED screens				
	108" - 110"	in structured varnish arctic white	11977	1.950 Euro
		in structured varnish lava black	11978	1.950 Euro
Technology cabinet with custom cutout for VC soundbar				
for the integration of VC bars such as Cisco Webex Room Kit (Plus) / Crestron Flex / Polycom Studio / etc. incl. mounting device				
	108" - 110"	in structured varnish arctic white	11979	2.175 Euro
		in structured varnish lava black	11980	2.175 Euro
VC camera cabinet in lateral loudspeaker cabinet new				
dimensions: 300 x 240 mm (W x H) positioning individually adjusted (per unit / side) Loudspeaker cabinet widened by about 100 mm				
	108" - 110"	left	11981	790 Euro
		right	11982	790 Euro

LED-Media wall_W9 - for 130" - 138" (16:9)

without side speaker cabinets

Base module

can not be upgraded

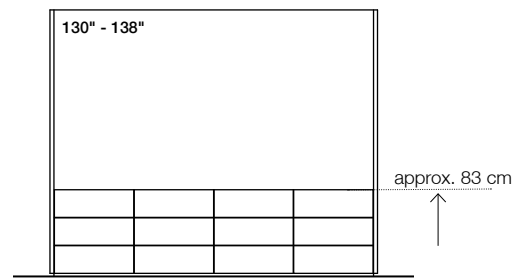

wall mounted, 4-door

Type / Design

Housing body, MDF doors and sides, finished with structured varnish.
With passive housing ventilation for individual technology integration.
Prepared for the integration of LED screens.
LED mount not included.

approx. Dimensions (W x D x H)

= individually adapted to LED screen

Furniture, outside

3130 x 320 x 2550 mm

Technology housing (*fittings not included)

4 x 720 x 280 x 740 mm

Mounting surface for LED screens (W x H)

3060 x 1720 mm

Max. screen weight

250 kg

Color** / Item number

arctic white

11983

lava black

11984

Base price for 1 unit

10.450 Euro

excluding transportation

(order of 3 more = scaled conditions!)



Shipping

on request

Options	Surface / Color	Item number	Sales price
Outer doors with speaker panels in fabric for external loud speaker includes shelf space for speakers approx. 730 x 220 mm (W x H) The technology compartments reduces accordingly.	structured varnish arctic white, fabric black	11963	890 Euro
	structured varnish lava black, fabric black	11964	890 Euro
Door lock (per door/piece)	nickel-plated, matt	12036	170 Euro
Shelf for technology housing	structured varnish arctic white	11966	55 Euro
	structured varnish lava black	11967	55 Euro
VC camera mount for lateral positioning on LED-Media wall W9 space: 240 x 150 mm (W x D)	metal, powder coated, black	11968	445 Euro

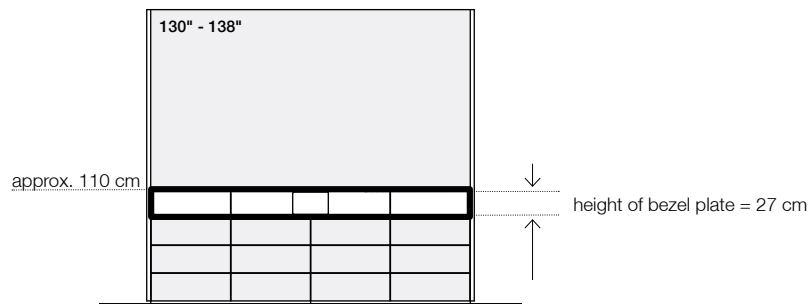
... optionally with bezel plate for VC integration

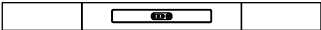

	approx. size	Surface / Color	Item number	Sales price
Technology cabinet / bezel plate with VC camera VC camera cabinet approx: 340 x 210 mm (W x H), below the LED screens				
	130" - 138"	in structured varnish arctic white	11985	2.395 Euro
		in structured varnish lava black	11986	2.395 Euro
Technology cabinet / bezel plate with VC camera, outside with fabric covers for external loud speaker (each 730 x 220 mm / W x H)				
	130" - 138"	in structured varnish arctic white	11987	2.725 Euro
		in structured varnish lava black	11988	2.725 Euro
Technology cabinet with custom cutout for VC soundbar for the integration of VC bars such as Cisco Webex Room Kit (Plus) / Crestron Flex / Polycom Studio / etc. incl. mounting device				
	130" - 138"	in structured varnish arctic white	11989	2.725 Euro
		in structured varnish lava black	11990	2.725 Euro

LED-Media wall_W9 - for 130" - 138" (16:9)

with lateral speaker cabinets

Base module

for line speaker cabinets and subwoofer

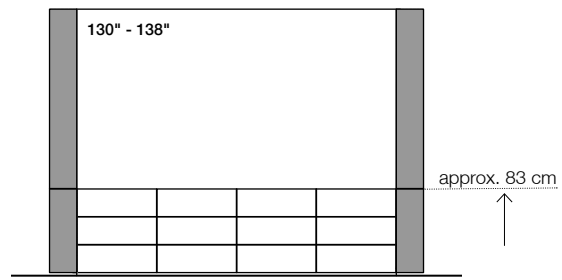

wall mounted, 4-door

Type / Design

Melamine housing, MDF doors and sides, finished with structured varnish. Lateral speaker cabinets covered with black fabric completely. With passive housing ventilation for individual technology integration. Prepared for the integration of LED screens. LED mount not included.

approx. Dimensions (W x D x H)

= individually adapted to LED screen

Furniture, outside	3580 x 320 x 2550 mm
Technology housing (*fittings not included)	4 x 720 x 280 x 740 mm
Mounting surface for LED screens (W x H)	3060 x 1720 mm
Speaker housing:	
- above / line speaker cabinet	180 x 240 x 1630 mm
- below / subwoofer	950 x 250 x 520 mm

Max. screen weight

250 kg

Color** / Item number

arctic white	11991
lava black	11992

Base price for 1 unit

15.130 Euro

excluding transportation

(order of 3 more = scaled conditions!)

Shipping



on request

Options	Surface / Color	Item number	Sales price
Door lock (per door/piece)	nickel-plated, matt	12036	170 Euro
Shelf for technology housing	structured varnish arctic white	11966	55 Euro
	structured varnish lava black	11967	55 Euro

** Structured varnish colors can be customized on request against surcharge.
Prices = net sales prices, excluding VAT (in Euro)

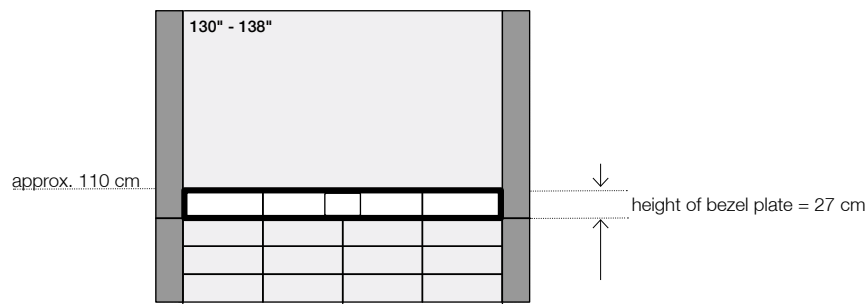
... optionally with bezel plate for VC integration



	approx. size	Surface / Color	Item number	Sales price
Technology cabinet / bezel plate with VC camera				
VC camera cabinet approx: 340 x 210 mm (W x H), below the LED screens				
	130" - 138"	in structured varnish arctic white	11993	2.395 Euro
		in structured varnish lava black	11994	2.395 Euro
Technology cabinet with custom cutout for VC soundbar				
for the integration of VC bars such as Cisco Webex Room Kit (Plus) / Crestron Flex / Polycom Studio / etc. incl. mounting device				
	130" - 138"	in structured varnish arctic white	11995	2.725 Euro
		in structured varnish lava black	11996	2.725 Euro
VC camera cabinet in lateral loudspeaker cabinet new				
dimensions: 300 x 240 mm (W x H) positioning individually adjusted (per unit / side) Loudspeaker cabinet widened by about 100 mm				
	130" - 138"	left	11997	790 Euro
		right	11998	790 Euro

LED-Media wall_W9 - for 162" - 165" (16:9) new

without side speaker cabinets

Base module

can not be upgraded

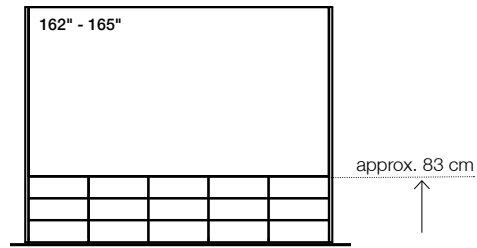
**wall mounted, 5-door****Type / Design**

Melamine housing, MDF doors and sides, finished with structured varnish.
 With passive housing ventilation for individual technology integration.
 Prepared for the integration of LED screens.
 LED mount not included.

approx. Dimensions (W x D x H)**= individually adapted to LED screen**

Furniture, outside

3750 x 320 x 2890 mm

Technology housing (*fittings not included)

5 x 680 x 280 x 740 mm

Mounting surface for LED screens (W x H)

3660 x 2060 mm

Max. screen weight

350 kg

Color / Item number**

arctic white

11999

lava black

12000**Base price for 1 unit****13.390 Euro**

excluding transportation

(order of 3 more = scaled conditions!)

Shipping**on request**

Options	Surface / Color	Item number	Sales price
Outer doors with speaker panels in fabric for external loud speaker includes shelf space for speakers approx. 730 x 220 mm (W x H) The technology compartments reduces accordingly.	structured varnish arctic white, fabric black	11963	890 Euro
	structured varnish lava black, fabric black	11964	890 Euro
Door lock (per door/piece)	nickel-plated, matt	12036	170 Euro
Shelf for technology housing	structured varnish arctic white	11966	55 Euro
	structured varnish lava black	11967	55 Euro
VC camera mount for lateral positioning on LED-Media wall W9 space: 240 x 150 mm (W x D)	metal, powder coated, black	11968	445 Euro

... optionally with bezel plate for VC integration

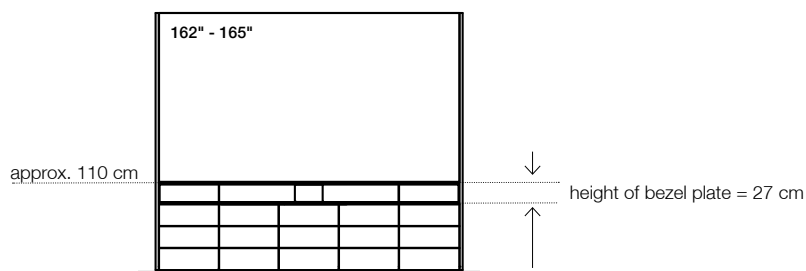

	approx. size	Surface / Color	Item number	Sales price
--	--------------	-----------------	-------------	-------------

Technology cabinet / bezel plate with VC camera

VC camera cabinet approx: 340 x 210 mm (W x H),
below the LED screens



162" - 165"	in structured varnish arctic white	12001	2.840 Euro
	in structured varnish lava black	12002	2.840 Euro

**Technology cabinet / bezel plate with VC camera,
outside with fabric covers for external loud speaker**
(each 730 x 220 mm / W x H)

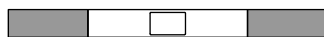

162" - 165"	in structured varnish arctic white	12003	3.170 Euro
	in structured varnish lava black	12004	3.170 Euro

Technology cabinet with custom cutout for VC soundbar
for the integration of VC bars such as Cisco Webex Room Kit (Plus)
/ Crestron Flex / Polycom Studio / etc. incl. mounting device

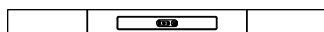

162" - 165"	in structured varnish arctic white	12005	3.170 Euro
	in structured varnish lava black	12006	3.170 Euro

LED-Media wall_W9 - for 162" - 165" (16:9) new

with lateral speaker cabinets

Base module

for line speaker cabinets and subwoofer

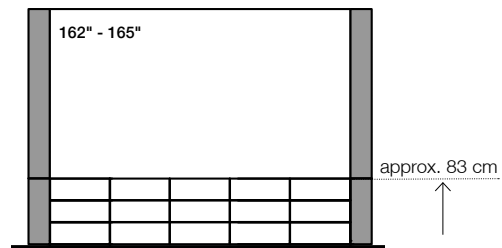

wall mounted, 5-door

Type / Design

Melamine housing, MDF doors and sides, finished with structured varnish. Lateral speaker cabinets covered with black fabric completely. With passive housing ventilation for individual technology integration. Prepared for the integration of LED screens. LED mount not included.

approx. Dimensions (W x D x H)

= individually adapted to LED screen

Furniture, outside

4180 x 320 x 2890 mm

Technology housing (*fittings not included)

5 x 680 x 280 x 740 mm

Mounting surface for LED screens (W x H)

3660 x 2060 mm

Speaker housing:

- above / line speaker cabinet

180 x 240 x 2070 mm

- below / subwoofer

910 x 250 x 520 mm

Max. screen weight

350 kg

Color** / Item number

arctic white

12007

lava black

12008

Base price for 1 unit

18.970 Euro

excluding transportation

(order of 3 more = scaled conditions!)

Shipping

on request

Options	Surface / Color	Item number	Sales price
Door lock (per door/piece)	nickel-plated, matt	12036	170 Euro
Shelf for technology housing	structured varnish arctic white	11966	55 Euro
	structured varnish lava black	11967	55 Euro

... optionally with bezel plate for VC integration

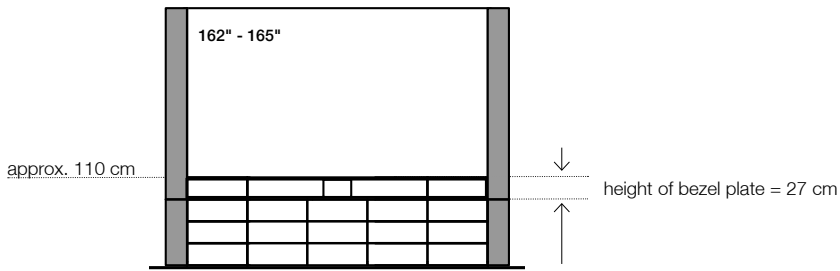

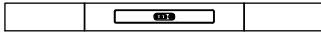
	approx. size	Surface / Color	Item number	Sales price
Technology cabinet / bezel plate with VC camera				
VC camera cabinet approx: 340 x 210 mm (W x H), below the LED screens				
	162" - 165"	in structured varnish arctic white	12009	2.840 Euro
		in structured varnish lava black	12010	2.840 Euro
Technology cabinet with custom cutout for VC soundbar				
for the integration of VC bars such as Cisco Webex Room Kit (Plus) / Crestron Flex / Polycom Studio / etc. incl. mounting device				
	162" - 165"	in structured varnish arctic white	12011	3.170 Euro
		in structured varnish lava black	12012	3.170 Euro
VC camera cabinet in lateral loudspeaker cabinet new				
dimensions: 300 x 240 mm (W x H) positioning individually adjusted (per unit / side) Loudspeaker cabinet widened by about 100 mm				
	162" - 165"	links rechts	12013 12014	790 Euro 790 Euro

General elements options

(not available for W6 due to serial production!)

Options	Surface / Color		Item number	Sales price
Custom structured varnish colors according to specification in RAL or NCS color system		single per order	INDIV_SL	590 Euro
Custom cutouts for free positioning of keypads, control panels or connector panels		inside unvarnished inside varnished	11945 11946	130 Euro 190 Euro
Sleeve for cable routing Ø 20 mm custom positioning, includes cutout and installation	stainless steel		10205	150 Euro
Cable passage Ø 60 mm for free positioning, incl. cutouts in housing	plastic	white black	10574 10719	140 Euro 140 Euro
custom furniture adjustment				10% surcharge on the base item
Preparation / integration of PZ lock, incl. chrome rosette when the PZ half-cylinder is supplied or self-installed				170 Euro
19-inch rack – 4HU for vertical mounting of 19-inch devices in a media column. Easy cable routing and maintenance through integrated mounting and swivel mechanism 520 x 205 x 195 mm (W x H x D) <u>Attention:</u> For space reasons the use of the rack is not possible in the W8 M and L - as well as in all S1. In the W8 L ² the rack fits only in the center cabinet.	metal, powder coated, black	black	10442	330 Euro
Delivery, set up and instruction by Holzmedia				on request

Replacement bezel plates for media column_W8

Replacement bezel plates	Surface / Color*	Sales price
Speaker cover standard spare part as in the main product	acoustic fabric black, back lacquered with structured varnish	
Size M		390 Euro
Size L		490 Euro
Size XL		590 Euro
Size XXL		690 Euro
Size M ²		590 Euro
Size L ²		690 Euro
Size XL ²		790 Euro
Custom speaker cover with custom cutout	acoustic fabric black, back lacquered in structured varnish arctic white or structured varnish lava black	
Size M		590 Euro
Size L		690 Euro
Size XL		790 Euro
Size XXL		890 Euro
Size M ²		790 Euro
Size L ²		890 Euro
Size XL ²		990 Euro
Custom VC bezel plate with cutout and mounting device for VC soundbar	made of MDF in structured varnish arctic white or structured varnish lava black	
Size M		590 Euro
Size L		690 Euro
Size XL		790 Euro
Size XXL		890 Euro
Size M ²		790 Euro
Size L ²		890 Euro
Size XL ²		990 Euro
VC camera housing below display with centrally divided speaker cover	structured varnish arctic white or lava black acoustic fabric black	
Size L		690 Euro
Size XL		790 Euro
Size XXL		890 Euro
Size M ²		790 Euro
Size L ²		890 Euro
Size XL ²		990 Euro

Additions

Supplementary furniture that rounds off our performance profile

Lectern_X3

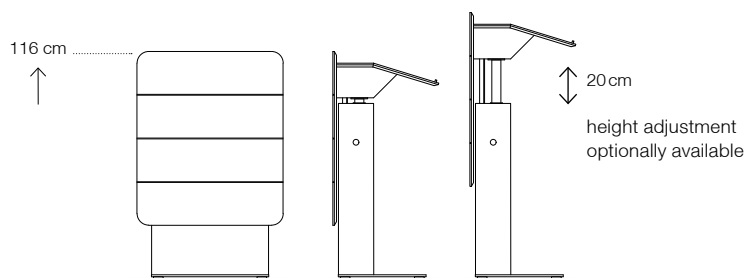

detached

Type / Design

Front cover, housing and doors made of MDF, finished with structured varnish.
With storage space for individual technology integration. Floor plate made of metal, powder coated.
Incl. lowering for water glass, tablet holder and laterally extensible stainless steel handles for carrying the lectern.

Type / Design storage surface:**Dimensions (W x D x H)**

Furniture, outside	750 x 545/180 x 1160 mm
Technology housing (*fittings not included)	560 x 140 x 780 mm
Storage surface (W x D)	670 x 350 mm

Color* / Item number

arctic white	12019
lava black	12020

Base price for 1 unit

excluding transportation	6.340 Euro
(order of 3 or more = scaled conditions!)	on request

Shipping

on request

Options	Surface / Color	Item number	Sales price
Electrical height adjustment about 20 cm reduced technology storage space = 560 x 140 x 200 mm + 200 x 140 x 550 mm (W x D x H)		10433	1.550 Euro
Preparation for additional microphone sound-insulated mount	black	12021	190 Euro
Custom cutout for connector panel	inside unvarnished inside varnished	12040 12041	130 Euro 190 Euro
Cutout for "Power Frame Cover Small" connector panel (3-fold)	inside unvarnished	12026	130 Euro
Installation frame with cover flap for "Power Frame Cover Small" (3-fold) without socket unit	white black	10502 10503	540 Euro 540 Euro
Reading light top left in lectern integrated	anodized aluminum black anodized aluminum	10435 10753	540 Euro 540 Euro
Door lock	nickel-plated, matt	10436	170 Euro
Lower shelf for technology housing only without height adjustment applicable!	structured varnish arctic white structured varnish lava black	10437 10752	50 Euro 50 Euro
Logopanel magnetic, 750 x 10 x 220 mm (W x D x H)	structured varnish arctic white structured varnish lava black	10236 10774	790 Euro 790 Euro
Dolly 790 x 620 x 140 mm (W x D x H)	made of MDF, black	10871	490 Euro

Media Cube_X4 - regular new

as a mobile media unit at table height

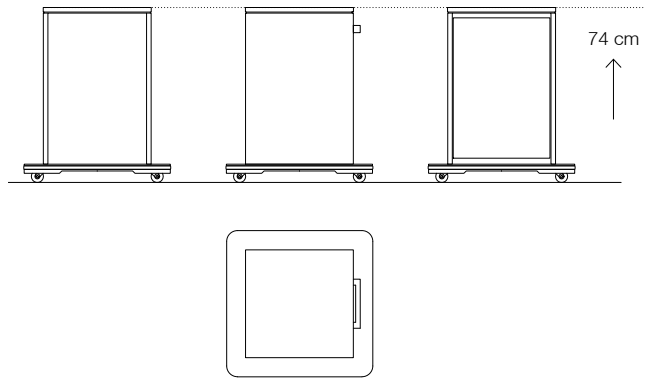

Type / Design

Housing and base plate made of MDF, finished with structured varnish.
With various options for the integration of technology
as well as data connector panels.

Type / Design storage surface:

Dimensions (W x D x H)

- Furniture, outside (base plate)	450/610 x 450/610 x 740 mm
- Technology housing (fittings not included)	430 x 430 x 640 mm
- Storage surface (W x D)	450 x 450 mm

Color* / Item number

arctic white	11324
lava black	11325

Base price for 1 unit

excluding transportation	1.660 Euro
(order of 3 or more = scaled conditions!)	on request

Shipping

on request

Options	Surface / Color	Item number	Sales price	
Cable roll holder on the back side of the mobile version	structured varnish arctic white	11345	160 Euro	
	structured varnish lava black	11346	160 Euro	
Custom cutouts for free positioning of keypads, control panels or connector panels	inside unvarnished	12040	130 Euro	
	inside varnished	12041	190 Euro	
Sleeve for cable routing Ø 20 mm custom positioning, includes cutout and installation	stainless steel	12042	150 Euro	
Cable passage Ø 60 mm for free positioning, incl. cutouts in body	plastic	white	12043	140 Euro
		black	12044	140 Euro
Door lock (per door/piece)	nickel-plated, matt	11334	170 Euro	
Shelf for technology housing	structured varnish arctic white	11878	55 Euro	
	structured varnish lava black	11879	55 Euro	
Data connector panel / media flap			on request	

Media Cube_X4 - high new

as a mobile media unit at standing table height

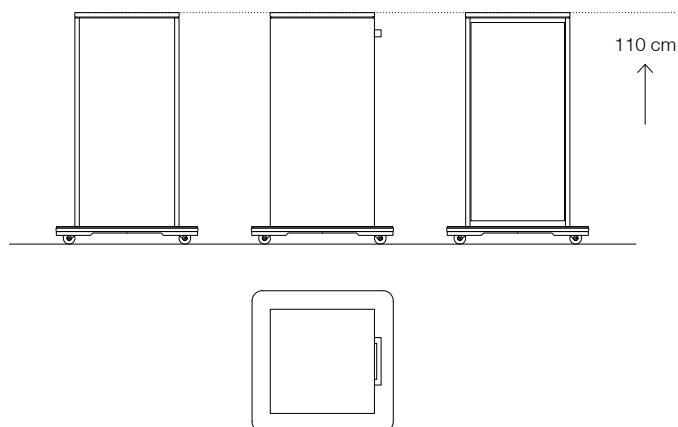

Type / Design

Housing and base plate made of MDF, finished with structured varnish.
With various options for the integration of technology
as well as data connector panels.

Type / Design storage surface:

Dimensions (W x D x H)

- Furniture, outside (base plate)	450/610 x 450/610 x 1100 mm
- Technology housing (fittings not included)	430 x 430 x 1000 mm
- Storage surface (W x D)	450 x 450 mm

Color* / Item number

arctic white	11326
lava black	11327

Base price for 1 unit

excluding transportation	1.880 Euro
(order of 3 or more = scaled conditions!)	on request

Shipping

on request

Options	Surface / Color	Item number	Sales price	
Cable roll holder on the back side of the mobile version	structured varnish arctic white	11345	160 Euro	
	structured varnish lava black	11346	160 Euro	
Custom cutouts for free positioning of keypads, control panels or connector panels	inside unvarnished	12040	130 Euro	
	inside varnished	12041	190 Euro	
Sleeve for cable routing Ø 20 mm custom positioning, includes cutout and installation	stainless steel	12042	150 Euro	
Cable passage Ø 60 mm for free positioning, incl. cutouts in body	plastic	white	12043	140 Euro
		black	12044	140 Euro
Door lock (per door/piece)	nickel-plated, matt	11334	170 Euro	
Shelf for technology housing	structured varnish arctic white	11878	55 Euro	
	structured varnish lava black	11879	55 Euro	
Data connector panel / media flap			on request	



**Holzmedia
Tables**

Table systems for conference and meetings rooms

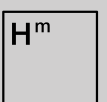

Holzmedia

Conference table_C12

cutouts and data connection panels not included



C12-240 for 8 people	Type / Design Dimension in cm	Color / Surface	Item number	Sales price
	Rectangular shape with rounded edges 240 x 120 x 74 (W x D x H)	Melamine white, chipboard Straight edge, for data connection panel with frame	R: 10114 B: 10115	2.960 Euro
	Rounded boat shape 240 x 110/120 x 74 (W x D x H)	White, table top in MDF data connection panel frameless possible	R: 10116 B: 10117	4.865 Euro
	Table top 25 mm thick, chamfered edge, table top 1-piece, substructure with 4 legs.	Oak, table top in MDF data connection panel frameless possible	R: 10118 B: 10119	4.865 Euro
		WhitePlex* Straight edge, for data connection panel with frame	R: 10122 B: 10123	8.240 Euro
		Shipping		on request
C12-320 for 10 people	Type / Design Dimension in cm	Color / Surface	Item number	Sales price
	Rectangular shape with rounded edges 320 x 120 x 74 (W x D x H)	Melamine white, chipboard Straight edge, for data connection panel with frame	R: 10124 B: 10125	3.760 Euro
	Rounded boat shape 320 x 110/120 x 74 (W x D x H)	White, table top in MDF data connection panel frameless possible	R: 10126 B: 10127	5.640 Euro
	Table top 25 mm thick, chamfered edge, table top 2-pieces, substructure with 4 (at WhitePlex=6) legs.	Oak, table top in MDF data connection panel frameless possible	R: 10128 B: 10129	5.640 Euro
		WhitePlex* Straight edge, for data connection panel with frame	R: 10132 B: 10133	10.240 Euro
		Shipping		on request
C12-480 for 14 people	Type / Design Dimension in cm	Color / Surface	Item number	Sales price
	Rectangular shape with rounded edges 480 x 140 x 74 (W x D x H)	Melamine white, chipboard Straight edge, for data connection panel with frame	R: 10134 B: 10135	5.565 Euro
	Rounded boat shape 480 x 130/140 x 74 (W x D x H)	White, table top in MDF data connection panel frameless possible	R: 10136 B: 10137	9.085 Euro
	Table top 25 mm thick, chamfered edge, table top 2-pieces, substructure with 6 legs.	Oak, table top in MDF data connection panel frameless possible	R: 10138 B: 10139	9.085 Euro
		WhitePlex* Straight edge, for data connection panel with frame	R: 10142 B: 10143	16.145 Euro
		Shipping		on request

Conference table_C12

cutouts and data connection panels not included

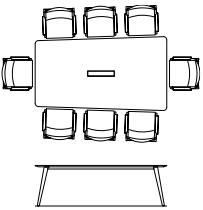
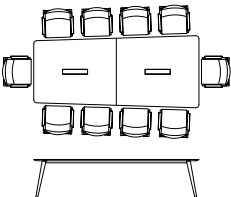
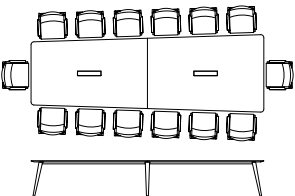
C12-240 for 6 - 8 people	Type / Design Dimension in cm	Color / Surface	Item number	Sales price
	Trapezium shape 240 x 135/120 x 74 (W x D x H)	Melamine white, chipboard Straight edge, for data connection panel with frame	10144	3.490 Euro
		White, table top in MDF data connection panel frameless possible	10145	5.070 Euro
		Oak, table top in MDF data connection panel frameless possible	10146	5.070 Euro
		WhitePlex* Straight edge, for data connection panel with frame	10148	8.715 Euro
	Table top 25 mm thick, chamfered edge, Table top 1-piece, substructure with 4 legs.	Shipping		on request
C12-320 for 8 - 10 people	Type / Design Dimension in cm	Color / Surface	Item number	Sales price
	Trapezium shape 320 x 140/120 x 74 (W x D x H)	Melamine white, chipboard Straight edge, for data connection panel with frame	10149	4.395 Euro
		White, table top in MDF data connection panel frameless possible	10150	6.870 Euro
		Oak, table top in MDF data connection panel frameless possible	10151	6.870 Euro
		WhitePlex* Straight edge, for data connection panel with frame	10153	10.590 Euro
	Table top 25 mm thick, chamfered edge, table top 2-pieces, substructure with 4 (at WhitePlex=6) legs.	Shipping		on request
C12-480 for 12 - 14 people	Type / Design Dimension in cm	Color / Surface	Item number	Sales price
	Trapezium shape 480 x 160/130 x 74 (W x D x H)	Melamine white, chipboard Straight edge, for data connection panel with frame	10154	6.240 Euro
		White, table top in MDF data connection panel frameless possible	10155	10.090 Euro
		Oak, table top in MDF data connection panel frameless possible	10156	10.090 Euro
		WhitePlex* Straight edge, for data connection panel with frame	10158	16.610 Euro
	Table top 25 mm thick, chamfered edge, table top 2-pieces, substructure with 6 legs.	Shipping		on request

Prices = net sales prices, excluding VAT (in Euro)

* for WhitePlex we recommend: delivery and installation by Holzmedia – invoicing according to actual expenses

Holzmedia GmbH

Conference table_C12

cutouts and data connection panels not included

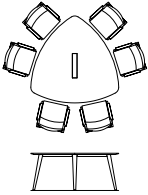
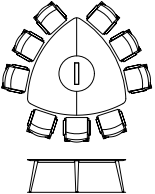
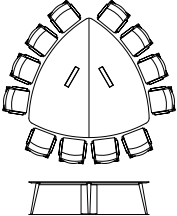
C12-173 for 6 people	Type / Design Dimension in cm	Color / Surface	Item number	Sales price
	Triangular shape 173 x 74 (L x H)	Melamine white, chipboard Straight edge, for data connection panel with frame	10159	3.160 Euro
		White, table top in MDF data connection panel frameless possible	10160	4.830 Euro
		Oak, table top in MDF data connection panel frameless possible	10161	4.830 Euro
		WhitePlex* Straight edge, for data connection panel with frame	10163	8.385 Euro
Shipping				on request
C12-220 for 9 people	Type / Design Dimension in cm	Color / Surface	Item number	Sales price
	Triangular shape 220 x 74 (L x H)	Melamine white, chipboard Straight edge, for data connection panel with frame	10164	4.570 Euro
		White, table top in MDF data connection panel frameless possible	10165	6.840 Euro
		Oak, table top in MDF data connection panel frameless possible	10166	6.840 Euro
		WhitePlex* Straight edge, for data connection panel with frame	10168	10.195 Euro
Shipping				on request
C12-270 für 12 people	Type / Design Dimension in cm	Color / Surface	Item number	Sales price
	Triangular shape 270 x 74 (L x H)	Melamine white, chipboard Straight edge, for data connection panel with frame	10169	6.275 Euro
		White, table top in MDF data connection panel frameless possible	10170	9.995 Euro
		Oak, table top in MDF data connection panel frameless possible	10171	9.995 Euro
		WhitePlex* Straight edge, for data connection panel with frame	10173	16.470 Euro
Shipping				on request

Conference table_C12

cutouts and data connection panels not included

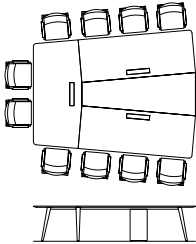
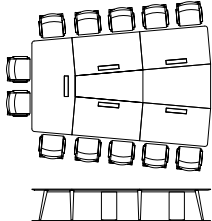
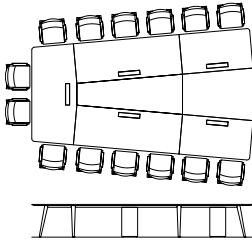
C12-340 for 10 people	Type / Design Dimension in cm	Color / Surface	Item number	Sales price
	V-shape with middle insert closed 341 x 212/270 x 74 (W x D x H)	Melamine white, chipboard Straight edge, for data connection panel with frame	10174	9.930 Euro
		White, table top in MDF data connection panel frameless possible	10175	13.845 Euro
		Oak, table top in MDF data connection panel frameless possible	10176	13.845 Euro
		WhitePlex* Straight edge, for data connection panel with frame	10178	19.195 Euro
	Table top 90 cm deep, 25 mm thick, chamfered edge, table top 3-pieces, with middle insert, structure lacquer. Substructure with 6 legs as well as cable routing in module.	Shipping		on request
C12-420 for 12 people	Type / Design Dimension in cm	Color / Surface	Item number	Sales price
	V-shape with middle insert closed 421 x 212/284 x 74 (W x D x H)	Melamine white, chipboard Straight edge, for data connection panel with frame	10179	13.830 Euro
		White, table top in MDF data connection panel frameless possible	10180	18.700 Euro
		Oak, table top in MDF data connection panel frameless possible	10181	18.700 Euro
		WhitePlex* Straight edge, for data connection panel with frame	10183	23.840 Euro
	Table top 90 cm deep, 25 mm thick, chamfered edge, table top 5-pieces, with middle insert 2-pieces, structure lacquer. Substructure with 8 legs as well as 2 cable routings in modules.	Shipping		on request
C12-500 for 14 people	Type / Design Dimension in cm	Color / Surface	Item number	Sales price
	V-shape with middle insert closed 500 x 212/298 x 74 (W x D x H)	Melamine white, chipboard Straight edge, for data connection panel with frame	10184	15.040 Euro
		White, table top in MDF data connection panel frameless possible	10185	20.450 Euro
		Oak, table top in MDF data connection panel frameless possible	10186	20.450 Euro
		WhitePlex* Straight edge, for data connection panel with frame	10188	26.640 Euro
	Table top 90 cm deep, 25 mm thick, chamfered edge, table top 5-pieces, with middle insert 2-pieces, structure lacquer. Substructure with 8 legs as well as 2 cable routings in modules.	Shipping		on request

Conference table_C12

cutouts and data connection panels not included

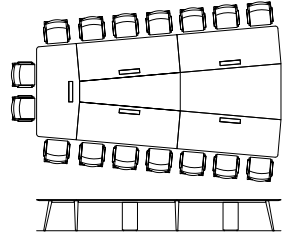
C12-580 for 16 people	Type / Design Dimension in cm	Color / Surface	Item number	Sales price
	V-shape with middle insert closed 580 x 212/312 x 74 (W x D x H)	Melamine white, chipboard Straight edge, for data connection panel with frame	10189	16.990 Euro
	Table top 90 cm deep, 25 mm thick, chamfered edge, table top 5-pieces, with middle insert 2-pieces, structure lacquer. Substructure with 8 legs as well as 2 cable routings in modules.	White, table top in MDF data connection panel frameless possible	10190	23.065 Euro
	Oak, table top in MDF data connection panel frameless possible	10191	23.065 Euro	
	WhitePlex* Straight edge, for data connection panel with frame	10193	30.285 Euro	
Shipping			on request	

Options conference table_C12

Options	Color / Surface	Item number	Sales price	
Cutout data connection panel for free positioning according to specification. Only data panels with frames can be used with WhitePlex and melamine tops. Flush-mounted installation is technically impossible in this case.			on request	
Sleeve for cable routing Ø 20 mm for free positioning, includes milled hole in top and installation.	stainless steel	12037 11158 (WPX)	150 Euro 150 Euro	
Cable passage Ø 60 mm for free positioning, incl. cutouts in body	plastic	white black	12038 12039	140 Euro 140 Euro
Milled groove Qi Wireless Charger Milled groove on underside of table can be freely positioned. Not available for WhitePlex tops.		10207	90 Euro	
Magnetic metal blind for cable routing along table leg.	black	10937 (corner foot) 10414 (midfoot)	170 Euro 170 Euro	
Fabric tube for routing the cable bundle to the floor outlet (up to 10 cables).	black	10209	140 Euro	
Fabric cover to cover the data connection panels on the underside of the table.	black	10936	140 Euro	
Cable routing module can be freely positioned below table top. For comfortable, invisible cable routing to floor connector as well as additional technology integration. Module equipped with maintenance hatch and feet.				
<ul style="list-style-type: none"> · Cable routing module 36 Dimensions: 36 x 36 x 71 cm (W x D x H) 	arctic white lava black	10210 10211	625 Euro 625 Euro	
<ul style="list-style-type: none"> · Cable routing module 66 Dimensions: 66 x 36 x 71 cm (W x D x H) 	arctic white lava black	10212 10213	840 Euro 840 Euro	
Data connection panel / media flap			on request	
Delivery, set up and instruction by Holzmedia In addition to simple Delivery At Place we also offer delivery including table installation. We especially recommend this for WhitePlex tops!			on request	

General note / instruction

Included in delivery / display mounts

All Elements furniture includes a mounting surface for commercially available display mounts complying with the VESA-Standard. The mounts themselves are not included in the scope of delivery.

Pricelist / Prices

This price list renders prior price lists invalid.

The market prices are recommended retail prices and are intended to be realistically achievable by dealers. (Prices are net prices excl. VAT – in Euro)

For shipments in countries outside of EU additional importation VAT and customs charges will occur and have to be paid by the recipient.

We reserve the right of slight amendments in construction, design and dimensions of our products.

Orders / Delivery

The delivered goods will be defined with the order confirmation.

Slight deviations in dimension, design or finish might be caused by the nature of our manufactured products. This doesn't justify any complaint, especially the identity of veneers and coatings can't be guaranteed. Re-orders included.

Wood is a natural product. Slight deviations of structure and color may occur and don't justify any complaint.

Customized products

Customized products are possible after consultation with production and against additional charge. A cancellation of such orders is not possible. Changes to an on-going order are only possible after consulting with production and paying already completed production steps, which includes time spent on drawings, etc.

General Terms and Conditions

Holzmedia GmbH

1. General, scope of application

(1) All quotations, deliveries and other services by Holzmedia GmbH – present and future – are based solely on these terms and conditions. Counter-confirmations by customers based on their own business or purchasing policies are herewith rejected. Customer conditions that are different from or not mentioned in these General Terms and Conditions can only become part of a contractual agreement if we have accepted them in writing.

(2) Our General Terms and Conditions apply only to persons who, at the time of signing the contract, are exercising their commercial or independent professional activity (entrepreneurs) and to juristic persons under public law and to special funds under public law.

2. Conclusion of contract, self-supply reservation, re-exports

(1) Orders will become legally binding with our confirmation by e-mail, the content of which alone defines the contractual relationship as well as the scope of delivery and services. Subsidiary agreements, verbal explanations by employees or representatives as well as changes to confirmed orders (including changes to ordered items) need to be confirmed in writing by us in order to become valid.

(2) Our obligation to deliver is subject to the provision that we have received the required goods correctly and on time from our suppliers (self-supply reservation).

(3) All products delivered by us are intended to remain in the country of delivery, chosen by the customer. The re-export of our products is in principle subject to the foreign trade regulations of the Federal Republic of Germany or the country of origin, respectively, and might require the customer to apply for permission. It is the responsibility of the customer to find out about and comply with the applicable regulations.

3. Prices

(1) If not otherwise agreed, our prices apply ex works or warehouse, excluding packaging, shipping and insurance, as well as any VAT or customs duties that might apply.

(2) Prices are always valid for the corresponding order only – they do not apply to past or future orders.

(3) In case of contracts with agreed delivery periods longer than five weeks, both parties may demand a revision of the agreed price corresponding to changes in price-determining factors that are outside the influence of the contracting parties, such as decreases or increases of cost due to collective trade agreements or changes in the price of raw materials. Changes in price will be limited in scope to compensate for the increase or decrease in cost incurred. Either party shall also be entitled to demand a change in price if delays incurred by the other party cause delivery time to be longer than five weeks. A price change cannot be made if a fixed price agreement has been made in the contract.

4. Payment

(1) If not otherwise agreed, payments are to be made within 10 days of the invoice date and for the full net amount. Initial orders have to be paid in advance or cash on delivery. Payment is deemed complete only when we can freely dispose of the amount (receipt of payment).

(2) Bills of exchange and checks shall only be accepted provisionally on agreement from us, and are deemed valid payments only after the amount has been credited to our account. Bank fees, discount charges, stamp fees on bills of exchange as well as any other fees plus VAT shall be charged to the customer according to private bank rates.

(4) Any offsetting is only permitted in the case of accepted, undisputed claims or claims that have been awarded the customer through final legal judgment. The customer is only entitled to exercise a right of retention insofar as his counterclaim is based on the same contractual relationship and this counterclaim is recognised by us, is undisputed or has been established by a court of law.

5. Delivery period, acceptance of delivery, default of acceptance

(1) If a delivery period is part of the agreement, then this period begins with our order confirmation, but not before the customer has provided us with all necessary documents, permits and clearances as well as answers to all technical questions and details about the desired options that are required by the customer.

(2) The delivery period will be considered fulfilled if the conditions leading to transfer of risk described in section 6 have been fulfilled before its expiration.

(3) The delivery period will be extended appropriately – even in case of a delay in delivery – in the event of a force majeure and all other unforeseen hindrances occurring after conclusion of contract yet outside of our responsibility, insofar as these hindrances are proven to be relevant to furnishing the due service. This also applies if said hindrances occur to one of our suppliers. Beginning and end of such hindrances will be communicated to the customer as soon as possible. Should the hindrance last longer than three months or is certain to last longer than three months both the customer and we are entitled to withdraw from the contract.

(4) If the customer is in arrears with the acceptance of delivered items or payment, we may, after fruitless expiry of an appropriate legally required extension determined by us, withdraw from the contract and/or demand compensation instead of services. When

pressing claims for damages we can without further proof demand compensation amounting to 20 % of the purchase price to compensate lost profit if the delivered item is a standard product or 100 % of the purchase price if the delivered item is a custom-made product built to specific customer requests and we had expenditures for production and preparing delivery.

The right of the contract parties to prove higher or significantly lower actual damage remains unaffected. The regulations for evaluating damages stipulated by law also remain unaffected, as long as our side of the contract has been completely fulfilled. In the case of a delay in the acceptance of delivery by the customer we also remain the right to charge resulting additional expenditures, especially storage costs.

6. Delivery, shipping and transfer of risk

(1) All shipments are at the expense and risk of the customer.

(2) In the absence of specific agreements regarding shipment we will determine the most appropriate mode of shipment (without any guarantee for the safest, fastest or cheapest mode of shipment).

(3) Partial shipments and services are permissible to a reasonable extent.

(4) If the delivery item enters another member state of the European Community, customers are obliged to inform us before the shipment of their VAT identification number, which will be used for managing the shipment, as well as their branch of industry. The same is true for the inclusion of further states subject to the rules of this provision.

(5) For deliveries the risk is transferred to the customer from the moment the delivery items leave our factory or warehouse. This also applies to partial deliveries. If there is a delay in shipment that is not our responsibility, the risk is transferred to the customer with the notification of readiness for shipment.

7. Warranty

(1) The client's obligation to inspect and report any defects is regulated by section 377 of the German commercial code (HGB).

(2) The limitation period for material defect claims is 12 months calculated from the transfer of risk. The statutory limitation period shall apply to claims for damages in the event of intent and gross negligence as well as in the event of injury to life, limb and health which are based on an intentional or negligent breach of duty by the user.

(3) Should the delivered goods show a not insignificant defect, we are entitled, at our discretion, to remedy the defect or to deliver a defect-free item.

(4) There is no warranty for wear and tear, especially for parts subject to wear and tear. There is also no warranty for damage or malfunction of the delivered goods if said damage is the result of improper handling or unsuitable operating conditions.

(5) We will be liable for damaged goods or defects of delivered goods only within the limits described in section 8.

(6) If the default lies with a third-party product, we are entitled to assign our liability claim against our supplier to the customer, advising them to take the appropriate (legal) recourse. We will be liable according to paragraphs 3 and 5 only if the claims against our supplier despite timely (judicial) recourse cannot be enforced, or the recourse in the individual case constitutes an undue burden.

8. Liability

(1) All claims for damages and reimbursement of costs of the customer (hereinafter referred to as "claims for damages") against us on whatever legal grounds, including breach of duties in connection with the contract, due to culpa in contrahendo, due to other breaches of duty or claims in tort, are excluded.

(2) However, this exclusion of liability shall not apply if intentional or grossly negligent conduct by us or by one of our representatives, employees or other vicarious agents is the basis for the claim for damages; if damage culpably caused by us or by one of our representatives, employees or other vicarious agents due to injury to body, life or health is the basis for the claim for damages; as well as with regard to the liability which is mandatory by law, in particular under the German Product Liability Act, and in the event of a breach of warranty promises by us or if we or one of our representatives, employees or other vicarious agents negligently breach a material contractual obligation. If we have negligently breached a material contractual obligation and no other of the aforementioned grounds for liability applies, our liability shall be limited to the amount of damages that are usually foreseeable. An essential contractual obligation is a contractual obligation the fulfillment of which makes the proper performance of the contract possible in the first place and on the observance of which the customer regularly relies and may rely. In all other respects, insofar as liability is not excluded, the statutory provisions for the amount of liability shall apply.

(3) In the event that our liability is excluded or limited according to abovementioned conditions, this shall also apply to the personal liability of our staff, employees, factory workforce, legal representatives and agents.

(4) Claims of the customer against the seller become statute-barred one year after knowledge of the facts giving rise to the claim, at the latest, however, five years after performance of the service, unless liability is unlimited.

9. Retention of ownership and securities

(1) We reserve ownership of delivered items until the buyer has fulfilled all contractual obligations – including future obligations – towards us (including accessory claims such as currency exchange costs, interest). If the customer has reached a current account agreement with us, we reserve ownership until the complete settlement of the acknowledged balance. When a check or bill of exchange is received, settlement sets in when the check or bill of exchange has been cashed and we can freely dispose of the amount without risk of recourse. If we have agreed to reimburse the customer via check or bill of exchange, retention of ownership also extends until the check or bill of exchange written by us has been cashed by the customer and does not expire with the credit entry of the received check on our part.

(2) The customer may process and sell the goods in the due course of business, but may not pledge them or assign them as security to third parties.

(3) The customer is obliged to treat goods subject to retention with due care and insure them adequately and at his own expense against theft, destruction and damage. In case of seizure, impounding, damage or loss the customer has to inform us immediately. The customer will bear all costs, in particular those arising from third-party actions against execution of seizure or those arising from an eventual release from seizure, unless these can be collected from a third party.

(4) In case of default of payment or violation of other contractual agreements on the part of the customer we are entitled to temporarily retrieve the goods subject to retention. The use of the right of retrieval does not constitute a withdrawal from the contract.

(5) On purchase the customer assigns to us the price of purchase and other claims (including the acknowledged balance in case of a current account

agreement, or the existing causal account balance in case of insolvency of the customer's business partner) in the amount of the invoice value of the retained goods, in case of resale, further processing or other legal reasons (insurance claim, tort); we herewith accept such assignment. We hereby authorize the Customer revocably to collect claims assigned to us for his own account and in his own name. This power of collection may only be withdrawn if the purchaser does not meet his payments properly. In this case the customer is obliged to inform us on demand of the relevant indications concerning the assigned claims, furnish us with the relevant documentation and communicate the assignment to the debtor.

(6) The processing or reworking of the delivered goods by the purchaser will always be executed on our behalf. If the delivered objects are joined permanently with other objects, we will acquire co-ownership in the new object corresponding to the ratio of the value of the delivered object to the value of the other objects at the time of processing. For the new object created through processing the same rules apply as to the delivered object subject to retention. If the delivered object is joined to other objects to create a new object that we do not own in its entirety, it is agreed now that the ownership of the new object is partially assigned to us (i.e. corresponding to the ratio of the value of the delivered object to the value of the other objects at the time of processing). The customer will manage our coownership without remuneration. The new object is subject to the same rules as the object delivered.

(7) Where the value that can be realized from the securities due to us according to the above provisions permanently exceeds the value of our claims against the customer by more than 10 %, we will release corresponding securities of our own choosing on request from the customer. The abovementioned coverage limit of 110% will be increased inasmuch as we are charged VAT for the utilization of collateral because of a delivery including VAT on the part of customer by the amount of said VAT.

10. Final provisions

(1) The customer allows us, without notification, to use personal data within the provisions of the Federal data protection act as far as this is necessary for the conclusion of contract provisions.

(2) Unless otherwise agreed in writing, the place of fulfillment of delivery is Burgstetten, Germany.

(3) In so far as the customer is a merchant within the meaning of the German Commercial Code, legal person or special funds under public law, the court at the seat of the company shall be the legal forum for all disputes arising directly or indirectly from the contractual relationship, including disputes concerning checks or bills of exchange. The same is true if the customer doesn't have a general place of jurisdiction within the Federal Republic of Germany or has transferred his place of residence or habitual abode to a country other than Germany after conclusion of the contract, or if the Customer's residence or habitual abode is unknown when the legal action is filed. We are however entitled to initiate legal proceedings against the customer at his own place of jurisdiction.

(4) The law of the Federal Republic of Germany under exclusion of the UN-purchase right shall be applicable for these General Terms and Conditions and the overall legal relation between the customer and us.

(5) Should individual provisions of the contract be or become ineffective or contain a loophole, the remaining provisions shall remain unaffected. The parties undertake to replace the invalid provision with a legally permissible provision that comes as close as possible to the economic purpose of the invalid provision or fills this gap.



Holzmedia

Contact

Holzmedia GmbH Office
Neue Straße 10 D-71576 Burgstetten
T +49 (0)71 91 34 47-0
info@holzmedia.de www.holzmedia.de

Holzmedia GmbH Showroom
Rathausstraße 61 D-71576 Burgstetten