

UC-Display column_W6 - size M (usually available from stock on short notice!)

for 50" to 65" displays
with up to 40 kg weight

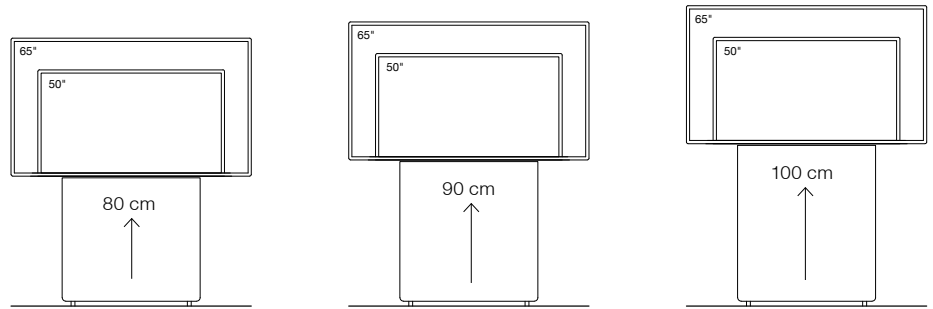

Type / Design

Housing and front cover made of MDF, finished with structured varnish.
For variable height display mounting/-positioning. Display mount not included.

Base furniture with plate height

80 cm

90 cm

100 cm

Dimensions (W x D x H)

Furniture, outside

850 x 150 x 1430 - 1830 mm

850 x 150 x 1430 - 1830 mm

850 x 150 x 1430 - 1830 mm

Technology housing

650 x 115 x 760 mm

650 x 115 x 860 mm

650 x 115 x 960 mm

Requirements for display integration

- max. display width

1600 mm

1600 mm

1600 mm

- max. display weight

40 kg

40 kg

40 kg

- recomm. display depth (incl. mount)

95 - 115 mm

95 - 115 mm

95 - 115 mm

- space for display mount (W x H)

645 x 580 mm

645 x 580 mm

645 x 580 mm

Color / Item number

arctic white

10072

10073

10074

basis rate for 1 piece

1.790 Euro

1.845 Euro

1.895 Euro

lava black

10579

10580

10581

basis rate for 1 piece

1.790 Euro

1.845 Euro

1.895 Euro

excluding transportation

(order of 3 more = scaled conditions!)

on request

on request

on request

Shipping within Europe

Delivery of 1-4 pieces per
pallet (further units = same
price)

12029

390 Euro

Delivery and instalation

on request

Options

Surface / Color

Item number

Sales price

Dual display board M²

- for 2 x 50" to 65" displays, dimensions 2200 x 610 mm (W x D)
Can only be used with wall attachment!

black MDF, clearly varnished

10767

1.090 Euro

VC camera mount

- for position over display, space 240 x 165 mm (W x D)
- for position below display, in front of corresponding bezel plate M (10909 / 10910),
space 300 x 240 mm (W x D)

metal, powder coated, black
metal, powder coated, black

10033
10919

220 Euro
220 Euro

L-foot

for free positioning on a wall, dimensions 740 x 305 mm (W x D)

metal, powder coated, black

10076

590 Euro

T-foot

for free positioning in a room, dimensions 740 x 410 mm (W x D)

metal, powder coated, black

10077

690 Euro

+ complementary bezel plates - size M

for the integration of UC-systems / VC-cameras as well as control panels and connector panels

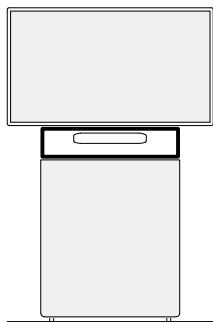

Type / Design

Made of MDF, finished with structured varnish. In width of 85 cm.

Universal,

without cutout*

Height 10 cm

arctic white lava black



Item number

10079 10582

Base price for 1 unit***

170 Euro 170 Euro

Height 20 cm

arctic white lava black

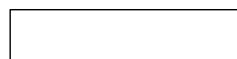

10082 10585

220 Euro 220 Euro

Height 30 cm**

arctic white lava black



10086 10589

275 Euro 275 Euro

Special - in height 20 cm:

... for POLY X30 + R30

Set, incl. mounting device

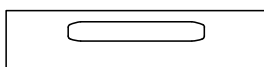

Item number

11955 11957

Base price for 1 unit***

330 Euro 330 Euro

... for POLY STUDIO

Set, incl. mounting device

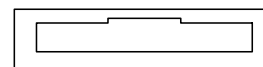

Item number

10729 10734

Base price for 1 unit***

330 Euro 330 Euro

... for Bose VB1

Set, incl. mounting device

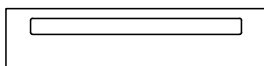

Item number

10733 10738

Base price for 1 unit***

330 Euro 330 Euro

... for AVER VB342+

Set, incl. mounting device

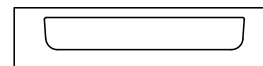

Item number

10895 10899

Base price for 1 unit***

330 Euro 330 Euro

... for Jabra PanaCast 50

Set, incl. mounting device

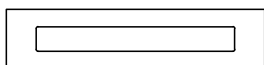

Item number

11215 11216

Base price for 1 unit***

330 Euro 330 Euro

... for Huddly IQ

Incl. mounting bracket/ socket



Item number

10845 10846

Base price for 1 unit***

270 Euro 270 Euro

Universal UC body

for VC bars up to 570 x 115 x 120 mm

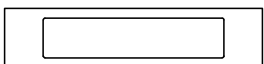

Item number

11397 11398

Base price for 1 unit***

330 Euro 330 Euro

Universal bezel

with tray and cable outlet, for example for Lenovo Think Smart



Item number

11211 11212

Base price for 1 unit***

330 Euro 330 Euro

...for mount VC camera

(exclusive mount 10919)



Item number

10909 10910

Base price for 1 unit***

270 Euro 270 Euro

Universal mounting device new without bezel, with depth compensation for systems wider than 85 cm

MDF, black

Item number

10964

Base price for 1 unit***

90 Euro

Shipping within Europe

10092

30 Euro

* Custom cutouts / drilled holes [from 10 pieces](#) on request possible.

** Can be used in combination with 80 cm and 90 cm high front panel (the height of the lower edge of the display in this case is max. 120 cm).

*** plus transport/delivery | order of 3 or more = scaled conditions

Add-on table_W6 - Size M (usually available from stock on short notice!) in height 74 cm - sitting height

for 50" to 65"- displays with up to 40 kg weight

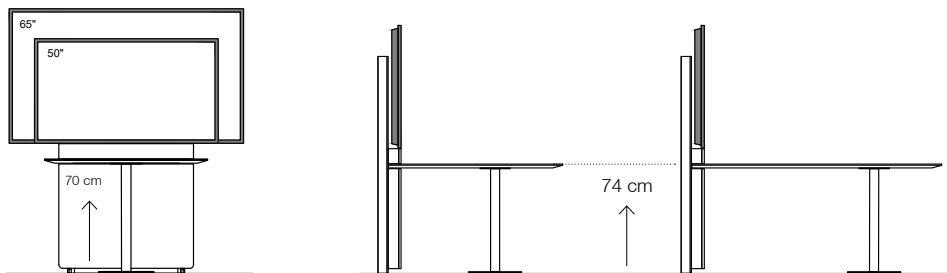

in / to combination
+ Base furniture with plate height 70 cm

Type / Design

Housing and front cover made of MDF, finished with structured varnish.
For variable height display mounting/-positioning. Display mount not included.

Dimensions (W x D x H)

Furniture, outside 850 x 150 x 1430 - 1830
Technology housing 650 x 115 x 660 mm

Requirements for display integration

- max. display width 1600 mm
- max. display weight 40 kg
- recomm. display depth (incl. mount) 95 - 115 mm
- space for display mount (W x H) 645 x 580 mm

Color / Item number

arctic white	11227	lava black	11228
basis rate for 1 piece	1.740 Euro	basis rate for 1 piece	1.740 Euro

excluding transportation
(order of 3 more = scaled conditions!)

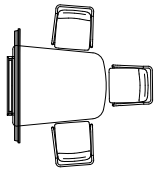
W6 Add-on table 110 for up to 3 people, sitting height	Type / Design Dimension in mm	Color / Surface	Item number	Sales price
	Trapezium shape with rounded edges 1180 x 800 / 1030 x 25 (W x D x H) Table leg with base plate, black	Melamin white, chipboard* straight edge, for data connection panel with frame	T: 11253	1.580 Euro
		Fenix white, table top in MDF chamfered edge, data connection panel frameless possible	T: 11259	2.320 Euro
		Fenix black, table top in MDF chamfered edge, data connection panel frameless possible	T: 11263	2.320 Euro

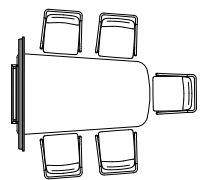
W6 Add-on table 160 for up to 5 people, sitting height	Type / Design Dimension in mm	Color / Surface	Item number	Sales price
	Trapezium shape with rounded edges 1680 x 800 / 1030 x 25 (W x D x H) Table leg with base plate, black	Melamin white, chipboard* straight edge, for data connection panel with frame	T: 11257	1.895 Euro
		Fenix white, table top in MDF chamfered edge, data connection panel frameless possible	T: 11260	2.850 Euro
		Fenix black, table top in MDF chamfered edge, data connection panel frameless possible	T: 11264	2.850 Euro

Shipping within Europe	Delivery of 1-3 pieces per pallet (further units = same price)	11278	390 Euro
-------------------------------	--	-------	-----------------

Delivery and instalation	on request
---------------------------------	------------

Options	Color / Surface	Item number	Sales price
L-Foot for free positioning on a wall, dimensions 740 x 305 mm (W x D)	metal, powder coated, black	10076	590 Euro
T-Foot for free positioning in a room, dimensions 740 x 410 mm (W x D)	metal, powder coated, black	10077	690 Euro

Add-on table_W6 - Size M (usually available from stock on short notice!) in height 105 cm - standing height

for 50" to 65"- displays with up to 40 kg weight

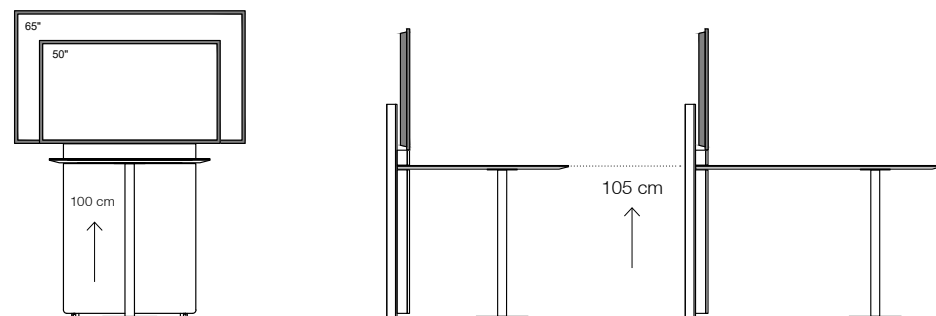

in / to combination
+ Base furniture with plate height 100 cm

Type / Design

Housing and front cover made of MDF, finished with structured varnish.
For variable height display mounting/-positioning. Display mount not included.

Dimensions (W x D x H)

Furniture, outside 850 x 150 x 1430 - 1930
Technology housing 650 x 115 x 960 mm

Requirements for display integration

- max. display width 1600 mm
- max. display weight 40 kg
- recomm. display depth (incl. mount) 95 - 115 mm
- space for display mount (W x H) 645 x 580 mm

Color / Item number

arctic white	10074	lava black	10581
basis rate for 1 piece	1.895 Euro	basis rate for 1 piece	1.895 Euro

excluding transportation
(order of 3 more = scaled conditions!)

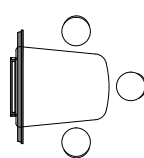
W6 Add-on table 110 for up to 3 people, sitting	Type / Design Dimension in mm	Color / Surface	Item number	Sales price
	Trapezium shape with rounded edges 1180 x 800 / 1030 x 25 (W x D x H) Table leg with base plate, black	Melamin white, chipboard* straight edge, for data connection panel with frame	T: 11256	1.635 Euro
		Fenix white, table top in MDF chamfered edge, data connection panel frameless possible	T: 11261	2.375 Euro
		Fenix black, table top in MDF chamfered edge, data connection panel frameless possible	T: 11265	2.375 Euro

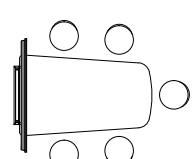
W6 Add-on table 160 for up to 5 people, sitting	Type / Design Dimension in mm	Color / Surface	Item number	Sales price
	Trapezium shape with rounded edges 1680 x 800 / 1030 x 25 (W x D x H) Table leg with base plate, black	Melamin white, chipboard* straight edge, for data connection panel with frame	T: 11258	1.950 Euro
		Fenix white, table top in MDF chamfered edge, data connection panel frameless possible	T: 11262	2.905 Euro
		Fenix black, table top in MDF chamfered edge, data connection panel frameless possible	T: 11266	2.905 Euro

Shipping within Europe Delivery of 1-3 pieces per pallet (further units = same price) 11278 **390 Euro**

Delivery and instalation on request

Options	Color / Surface	Item number	Sales price
L-Foot for free positioning on a wall, dimensions 740 x 305 mm (W x D)	metal, powder coated, black	10076	590 Euro
T-Foot for free positioning in a room, dimensions 740 x 410 mm (W x D)	metal, powder coated, black	10077	690 Euro

Prices = net sales prices, excluding VAT (in Euro)

*Delivery time for melamin table tops, as well as tabletops with cutouts, is about 8 weeks.

UC-Display column_W6 - size L (usually available from stock on short notice!)

for 70" to 80" displays
with up to 60 kg weight

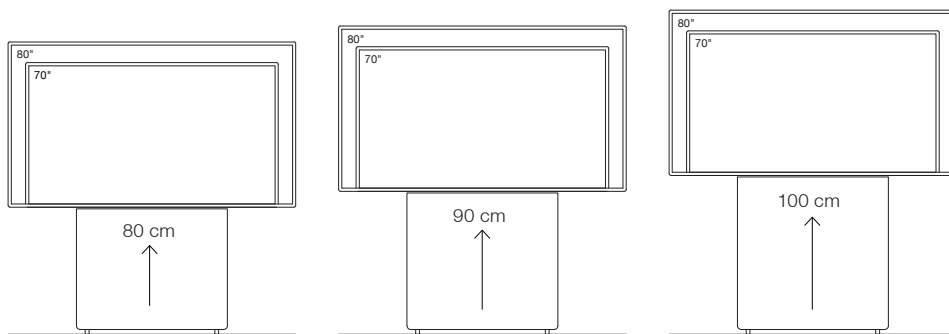

Type / Design

Housing and front cover made of MDF, finished with structured varnish.
For variable height display mounting/-positioning. Display mount not included.

Base furniture with plate height

Dimensions (W x D x H)

	80 cm	90 cm	100 cm
Furniture, outside	950 x 180 x 1650 - 1950 mm	950 x 180 x 1650 - 1950 mm	950 x 180 x 1650 - 1950 mm
Technology housing	750 x 140 x 760 mm	750 x 140 x 860 mm	750 x 140 x 960 mm

Requirements for display integration

	80 cm	90 cm	100 cm
- max. display width	1900 mm	1900 mm	1900 mm
- max. display weight	60 kg	60 kg	60 kg
- recomm. display depth (incl. mount)	120 - 130 mm	120 - 130 mm	120 - 130 mm
- space for display mount (W x H)	745 x 620 mm	745 x 620 mm	745 x 620 mm

Color / Item number

	80 cm	90 cm	100 cm
arctic white	10612	10613	10614
basis rate for 1 piece	2.110 Euro	2.185 Euro	2.260 Euro
lava black	10620	10621	10622
basis rate for 1 piece	2.110 Euro	2.185 Euro	2.260 Euro
excluding transportation (order of 3 more = scaled conditions!)	on request	on request	on request

Shipping within Europe

Delivery of 1-4 pieces per pallet (further units = same price)	12029	390 Euro
--	-------	-----------------

Delivery and installation

on request

Options

Options	Surface / Color	Item number	Sales price
Dual display board L² - for 2 x 70" to 80" displays, dimensions 2600 x 670 mm (W x D) Can only be used with wall attachment!	black MDF, clearly varnished	10866	1.390 Euro
VC camera mount - for position over display, space 240 x 165 mm (W x D) - for position below display, in front of corresponding bezel plate L (10915 / 10916), space 300 x 240 mm (W x D)	metal, powder coated, black	10033	220 Euro
	metal, powder coated, black	10919	220 Euro
L-Foot for free positioning on a wall, dimensions 840 x 335 mm (W x D)	metal, powder coated, black	10616	690 Euro
T-Foot for free positioning in a room, dimensions 840 x 460 mm (W x D)	metal, powder coated, black	10617	840 Euro

+ complementary bezel plates - size L

for the integration of UC-systems / VC-cameras as well as control panels and connector panels

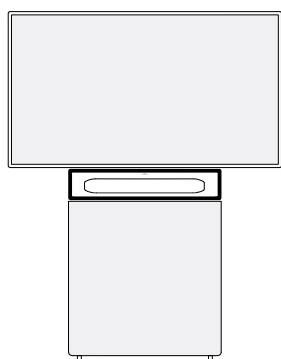

Type / Design

Made of MDF, finished with structured varnish. In width of 95 cm.

Universal,

without cutout*

Height 10 cm

arctic white lava black

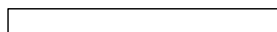

Item number

10623 10634

Base price for 1 unit***

220 Euro 220 Euro

Height 20 cm

arctic white lava black

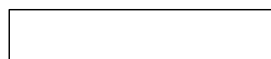

10626 10637

275 Euro 275 Euro

Height 30 cm**

arctic white lava black



10630 10641

330 Euro 330 Euro

Speziell - in Höhe 20 cm:

... for POLY STUDIO

Set, incl. mounting device

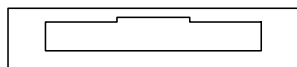

Item number

10859 10860

Base price for 1 unit***

390 Euro 390 Euro

... for POLY X50

Set, incl. mounting device

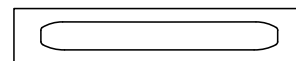

Item number

10731 10736

Base price for 1 unit***

390 Euro 390 Euro

... for Logitech Rally Bar Mini new

Set, incl. mounting device

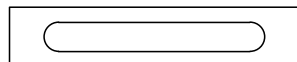

Item number

11316 11317

Base price for 1 unit***

390 Euro 390 Euro

... for Bose VB1

Set, incl. mounting device

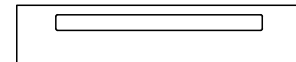

Item number

10922 10923

Base price for 1 unit***

390 Euro 390 Euro

... for Cisco Room Kit

Set, incl. mounting device

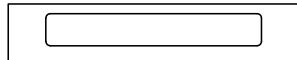

Item number

10904 10905

Base price for 1 unit***

390 Euro 390 Euro

... for Jabra PanaCast 50

Set, incl. mounting device

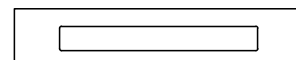

Item number

11217 11218

Base price for 1 unit***

390 Euro 390 Euro

Universal UC body

for VC bars up to 670 x 140 x 120 mm

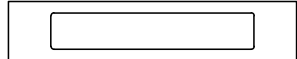

Item number

11399 11400

Base price for 1 unit***

390 Euro 390 Euro

Universal bezel

with tray and cable outlet,
for example for Lenovo Think Smart

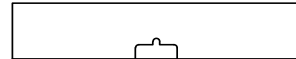

Item number

11213 11214

Base price for 1 unit***

390 Euro 390 Euro

... for mount VC camera

(exclusive mount 10919)



Item number

10915 10916

Base price for 1 unit***

330 Euro 330 Euro

Universal mounting device new
without bezel, with depth compensation
for systems wider than 95 cm

Item number

MDF, black

11405

Base price for 1 unit***

90 Euro

Shipping within Europe

10092

35 Euro

* Custom cutouts / drilled holes [from 10 pieces](#) on request possible.

** Can be used in combination with 80 cm and 90 cm high front panel (the height of the lower edge of the display in this case is max. 120 cm).

*** plus transport/delivery | order of 3 or more = scaled conditions